

M. G. B. E. N. A. N.

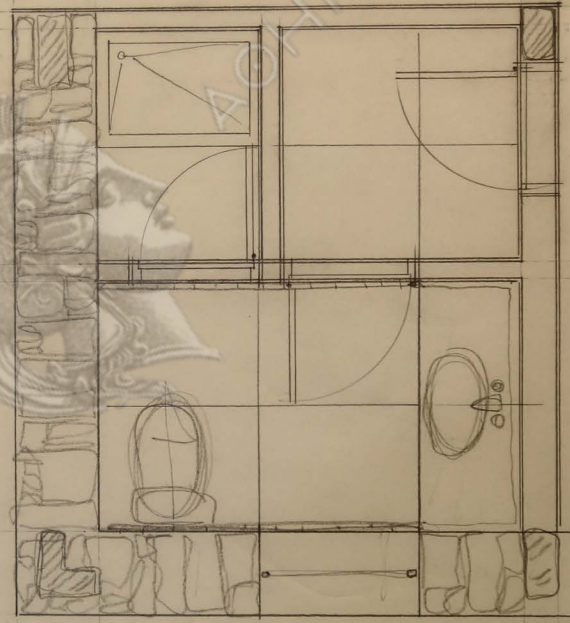

AKADHMIYA ACHNAN

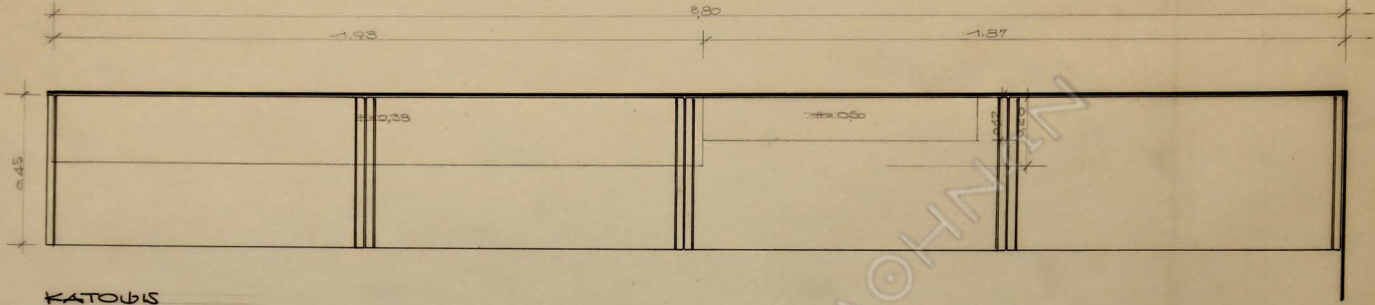

KATO
110
110

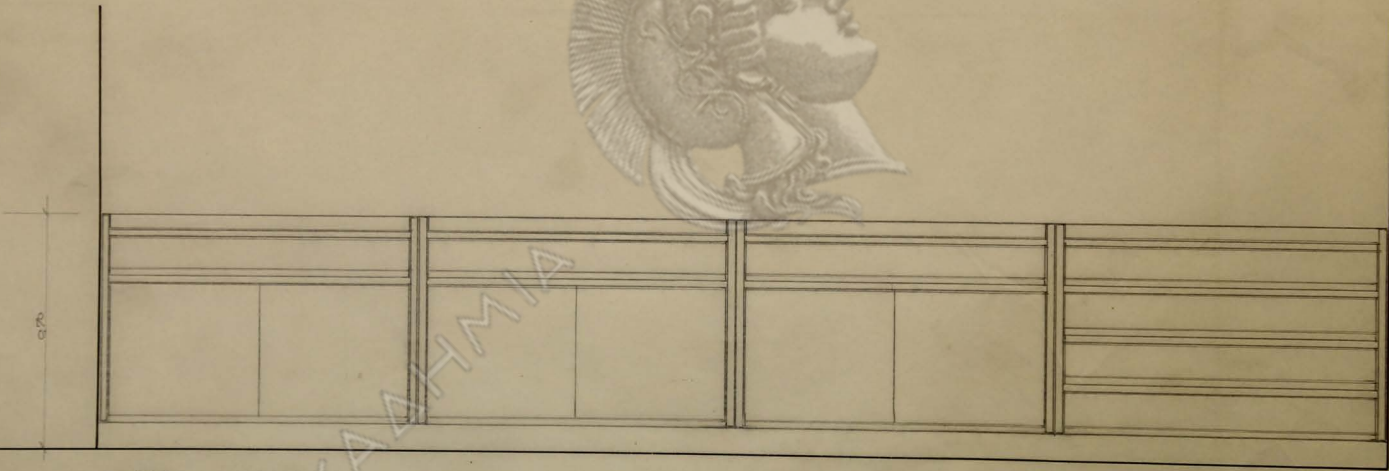

0
110
110

ΑΟΗΝΕΝ

ΑΚΑΔΗΜΙΑ

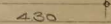
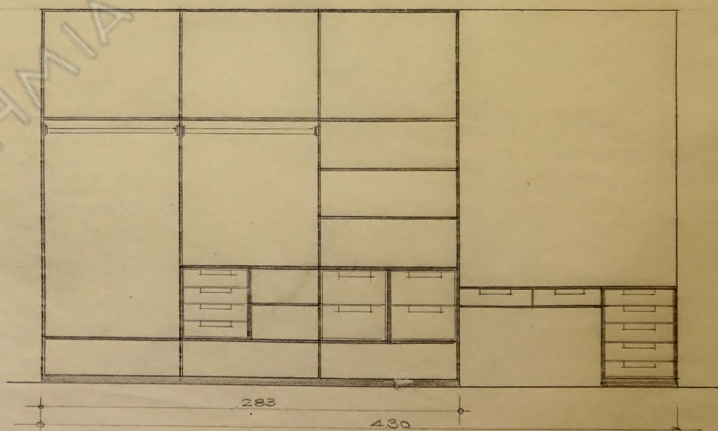
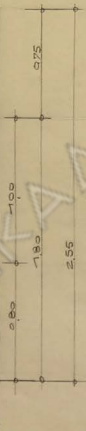
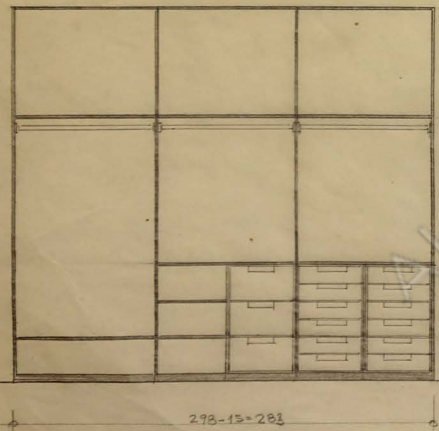
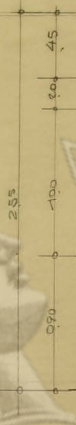
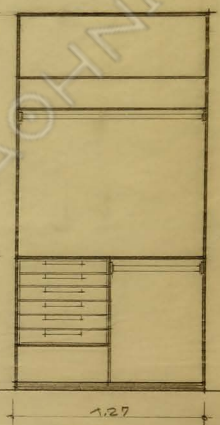
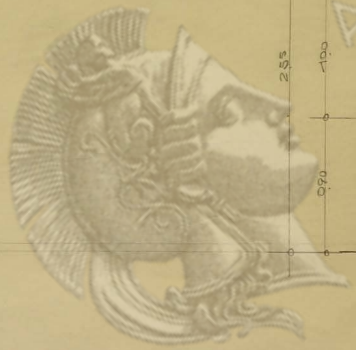
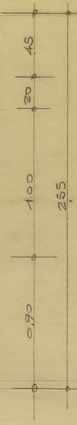
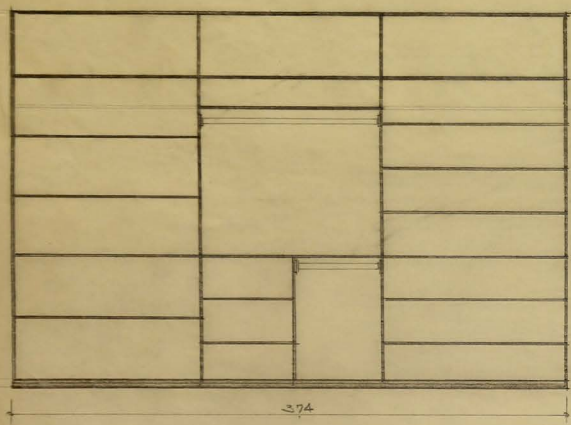

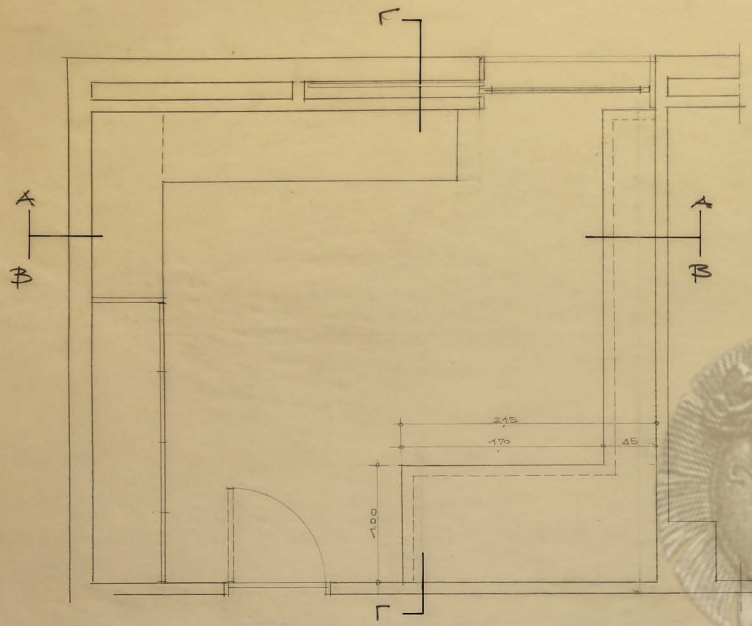

ΚΑΤΩΣ 1:20

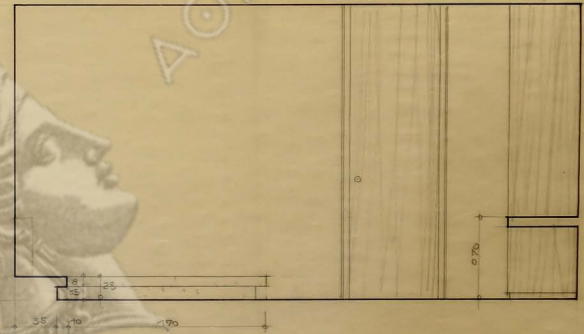

Α-Α 1:10

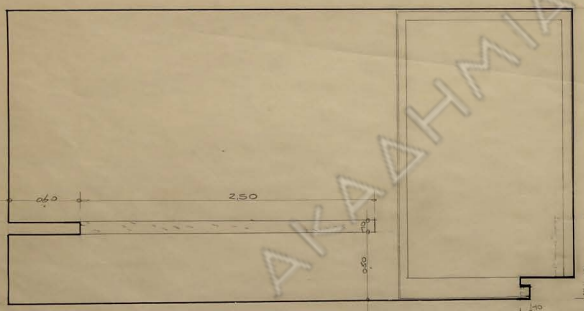

Β-Β 1:10

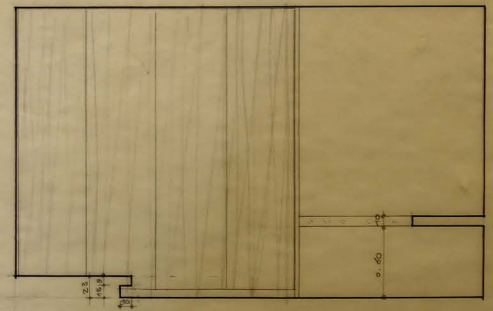

1:10

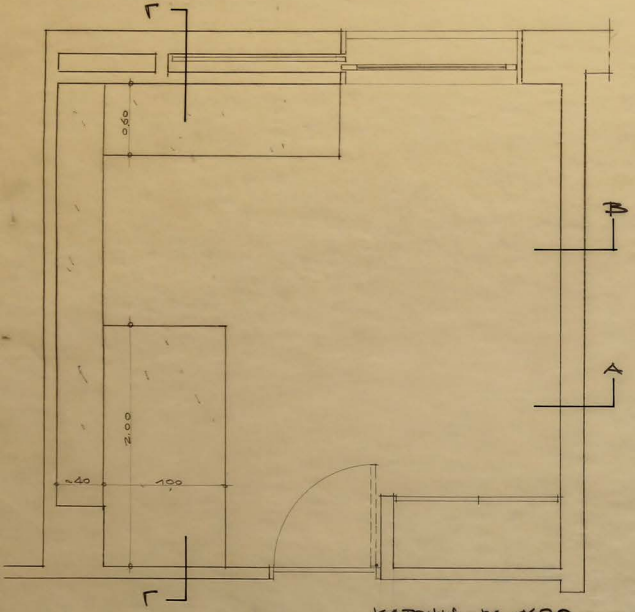

ΚΑΤΩΛΙΣ Κ. 1/20



ΤΟΙΧ Β-Β

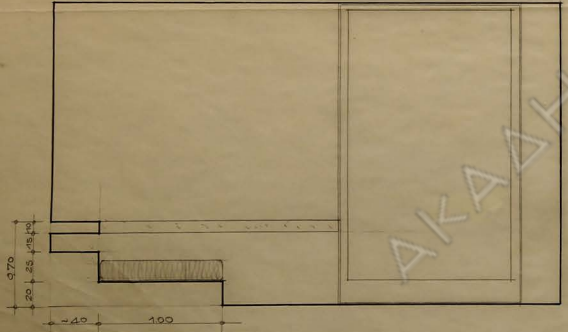

ΤΟΙΧ Α-Α

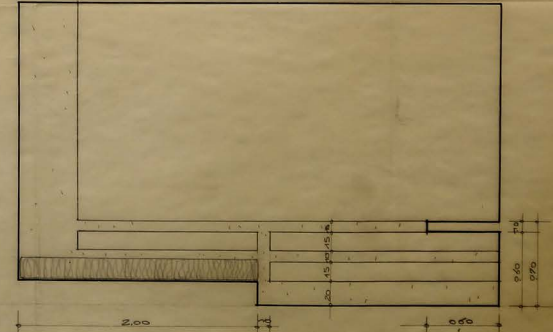

ΤΟΙΧ Γ-Γ

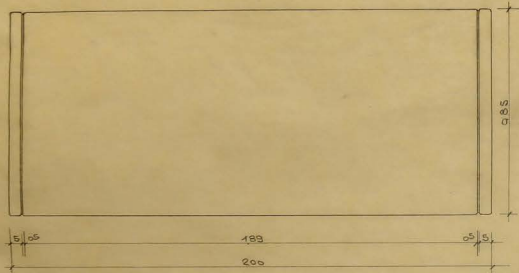

ΚΑΤΩΦΛΙΣ ΕΛ. 1/10

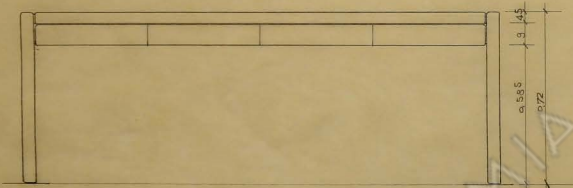

ΠΡΟΣΟΦΛΙΣ

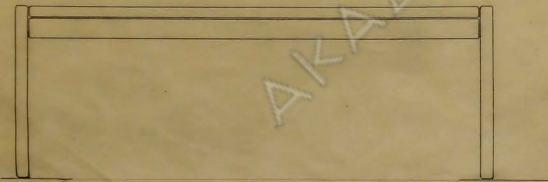

ΠΙΣΤΡΟΦΛΙΣ



ΑΡΙΣΤ. ΟΥΡΟΣ ΕΛ. 1/11

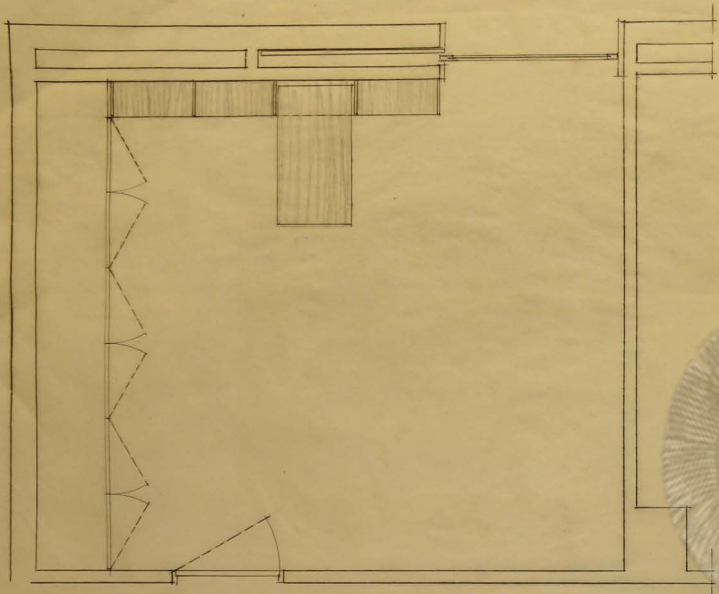

ΑΘΗΝΑΝ

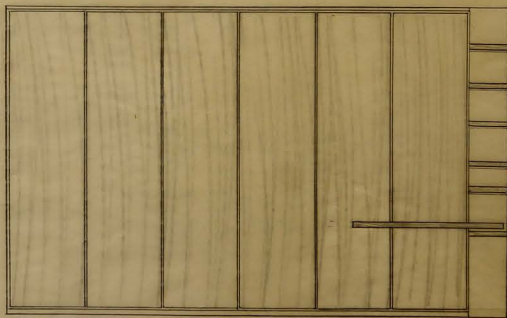
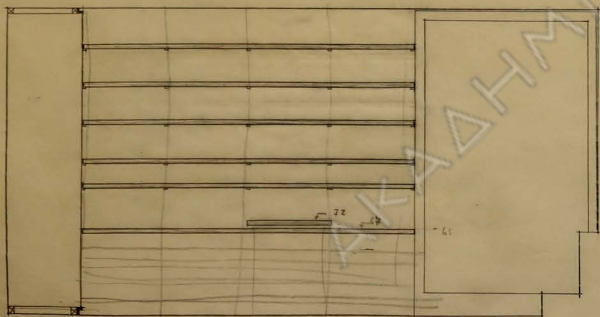

ΚΑΔΗΜΙΑ

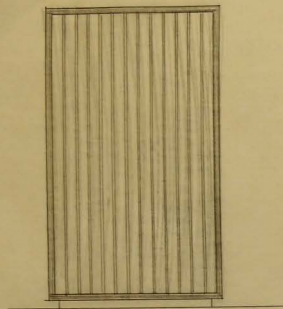

ΟΒΙΣ ΚΑΙΝΑΣ 1/20

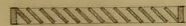

ΚΑΤΩΝΙ ΚΑΙΝΑΣ 1/20

ΔΙΑΧΕΡΙΣΤΙΚΟ ΚΗΠΟΥ

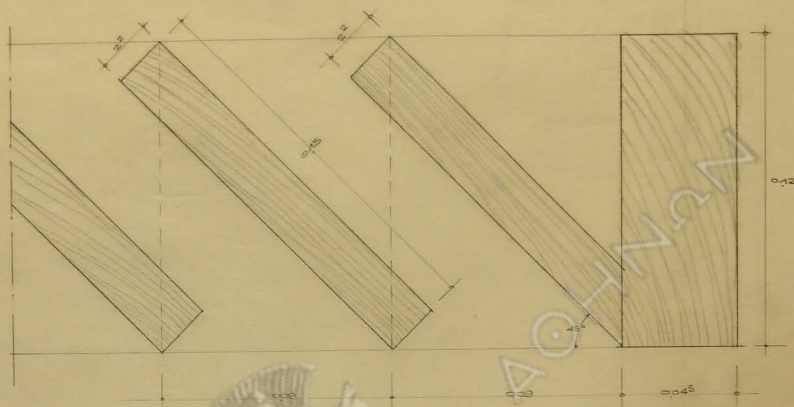

ΛΕΠΤ. ΟΡΙΖΟΝΤΙΑ ΤΟΜΗ ΚΑΙΝΑΣ

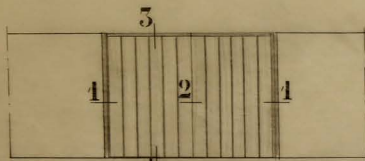

ΟΒΙΣ ΚΑΙΝΑΣ 1/20



ΚΑΤΩΝΙ ΚΑΙΝΑΣ 1/20

ΠΟΡΤΑ ΚΗΠΟΥ

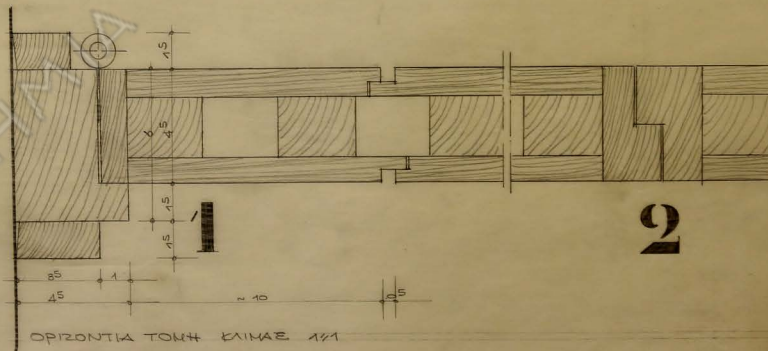

ΟΡΙΖΟΝΤΙΑ ΤΟΜΗ ΚΑΙΝΑΣ 1/21

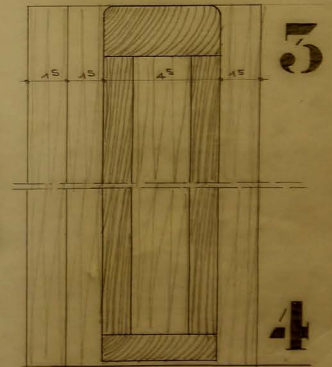

ΚΑΤΑΚΟΡΥΦΗ ΤΟΜΗ ΚΑΙΝΑΣ 1/21

ΟΙΚΙΑ Ε. ΠΡΩΤΟΝΟΤΑΡΙΟΥ
ΛΕΠΤ. ΔΙΑΧΕΡΙΣΤΙΚΟΥ ΠΟΡΤΑΣ ΚΗΠΟΥ
ΑΡΧΙΤΕΚΤΟΝ Ν. ΖΑΪΖΑΝΑΚΗΣ

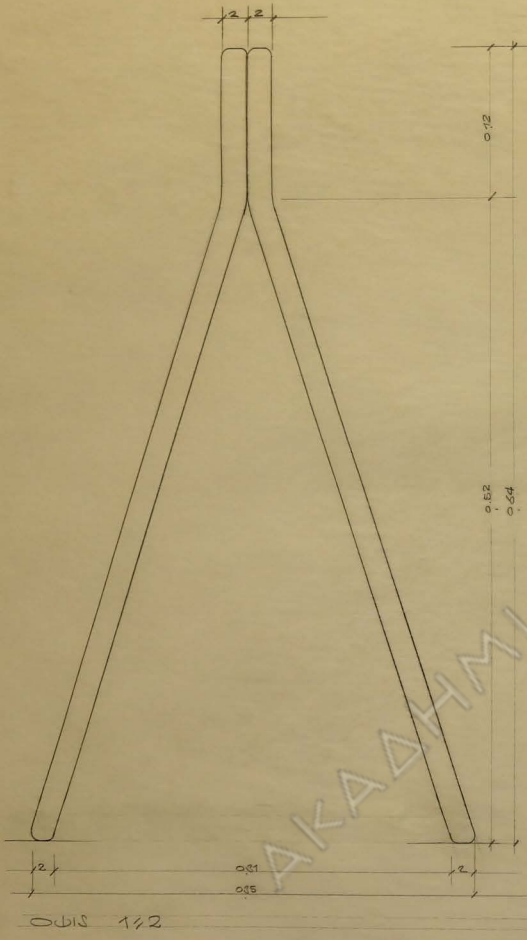

AKADHMIA

ΑΟΗΝΑΝ

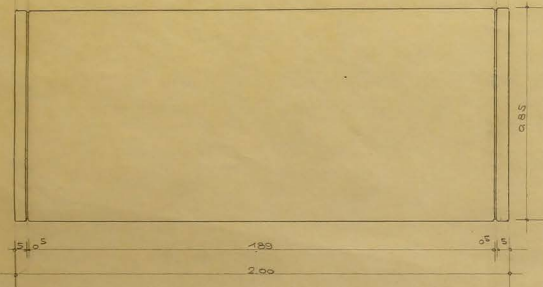

ΚΑΤΟΠΙΣ ΚΑ. 12/10

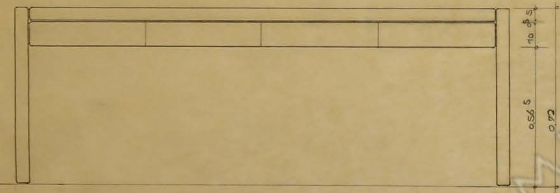

ΠΡΟΠΕΡΙΣ

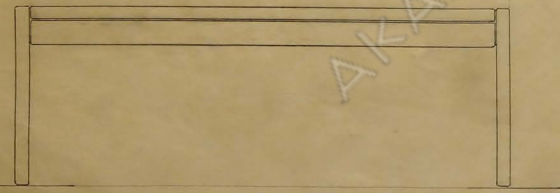

ΠΡΟ ΟΨΕΩΣ



ΛΕΙΤΟΥΡΓΕΙΑ ΟΥΡΟΣ ΚΑ. 1/1

AKADHMIA AΘHNAN

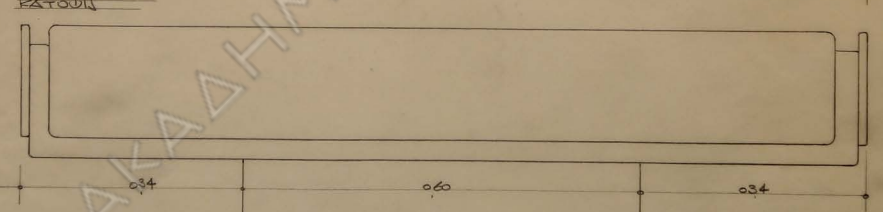
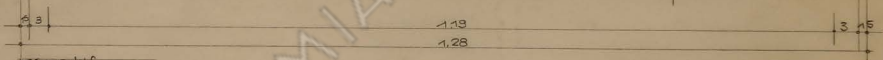
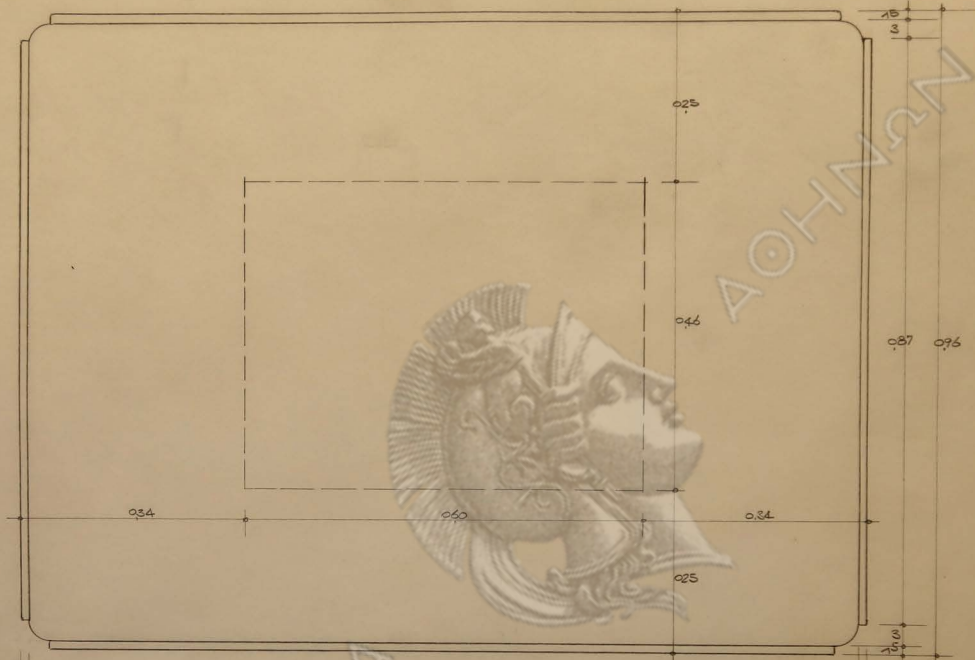

0.119

ΑΘΗΝΑ

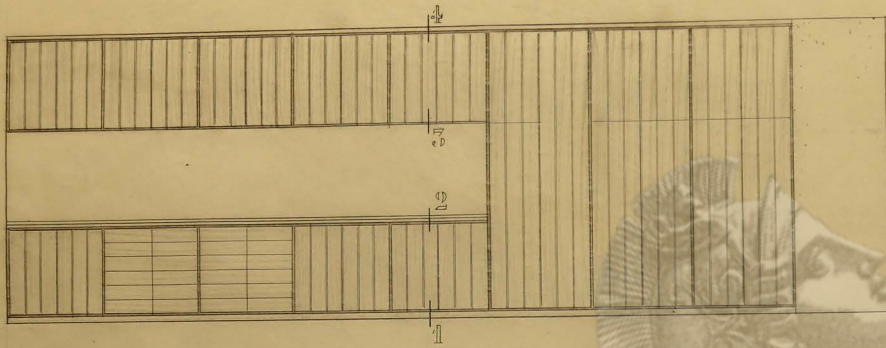

0012 A-A

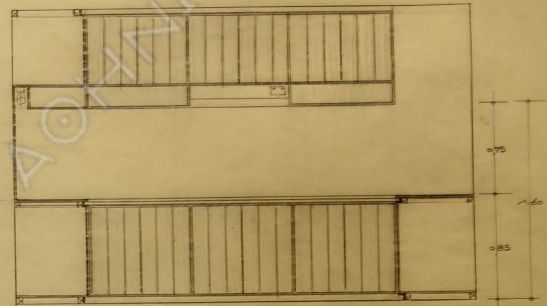

0012 B-B

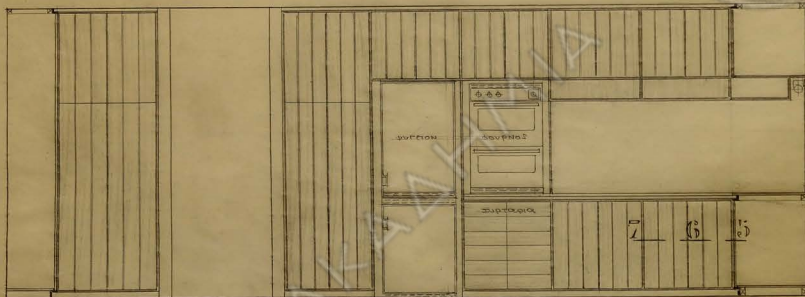

0012 I-I

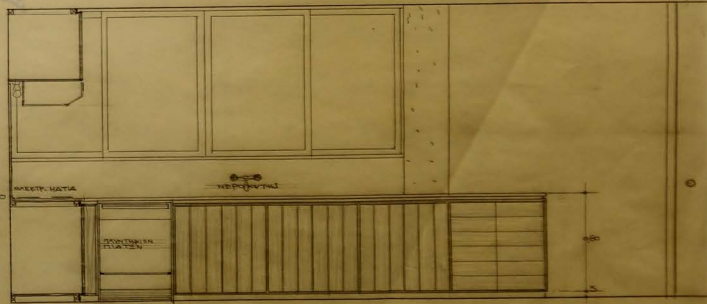

0012 A-A

ΣΙΕΙΑ Ε. ΠΡΩΤΟΝΟΤΑΡΙΟΥ
ΔΙΑΜΟΡΦΩΣΗ ΚΟΥΖΙΝΑΣ

ΕΛΛΗΝΑΣ 1920
ΑΡΧΙΤΕΚΤΟΝ Ν. ΠΑΠΑΝΔΡΕΟΥ

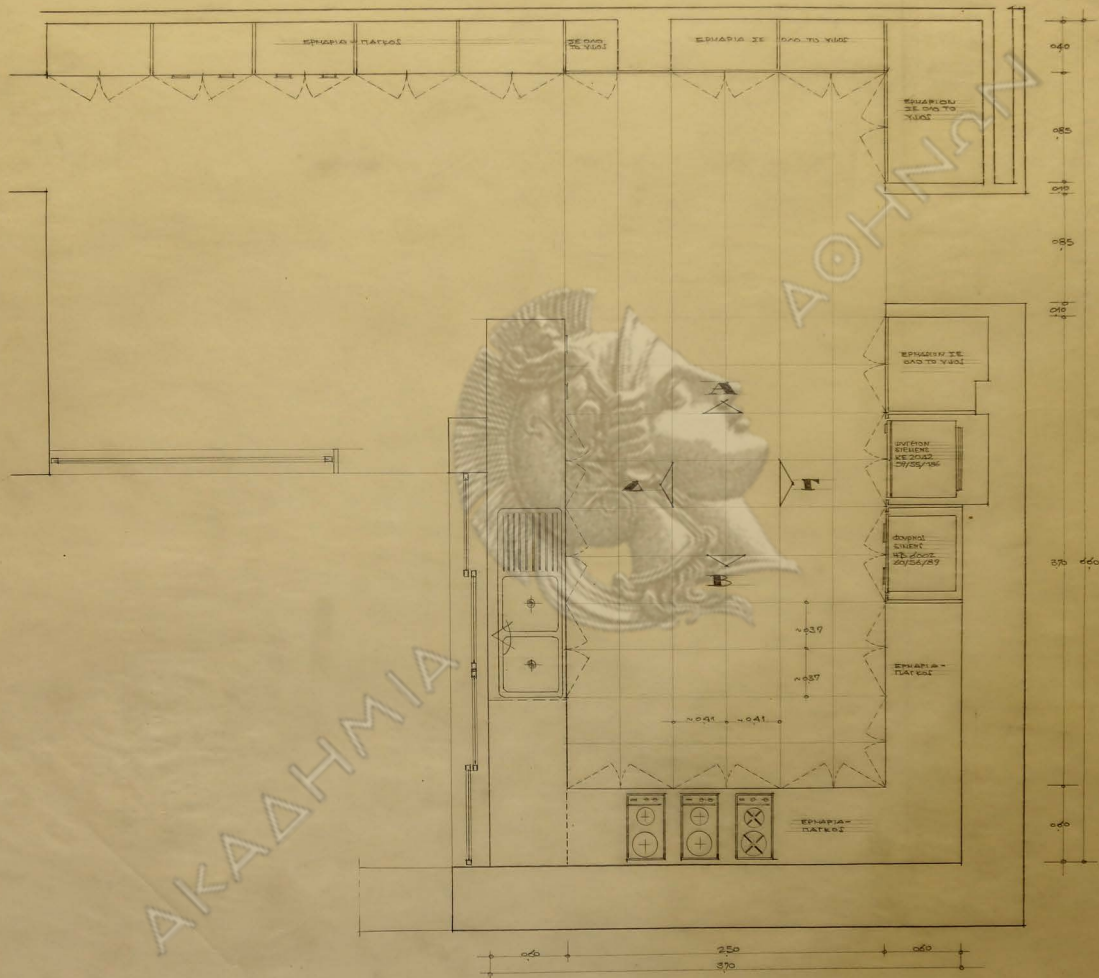

ΟΙΚΙΑ Ε. ΠΡΩΤΟΝΟΤΑΡΙΟΥ
ΔΙΑΜΟΡΦΩΣΗ ΚΟΥΖΙΝΑΣ

ΚΑΙΜΑΣ 13 20
ΑΡΧΙΤΕΚΤΟΝ Ν. ΠΑΛΑΙΟΥΣ

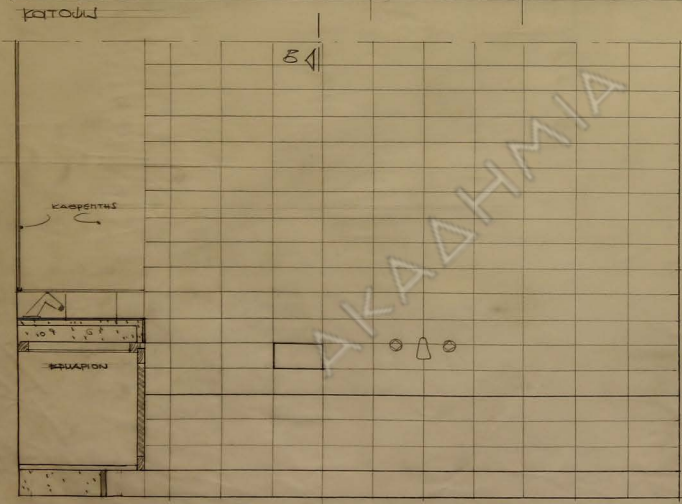
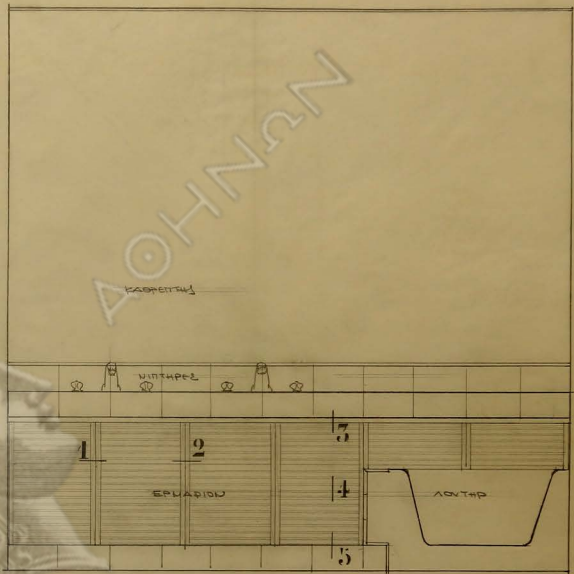
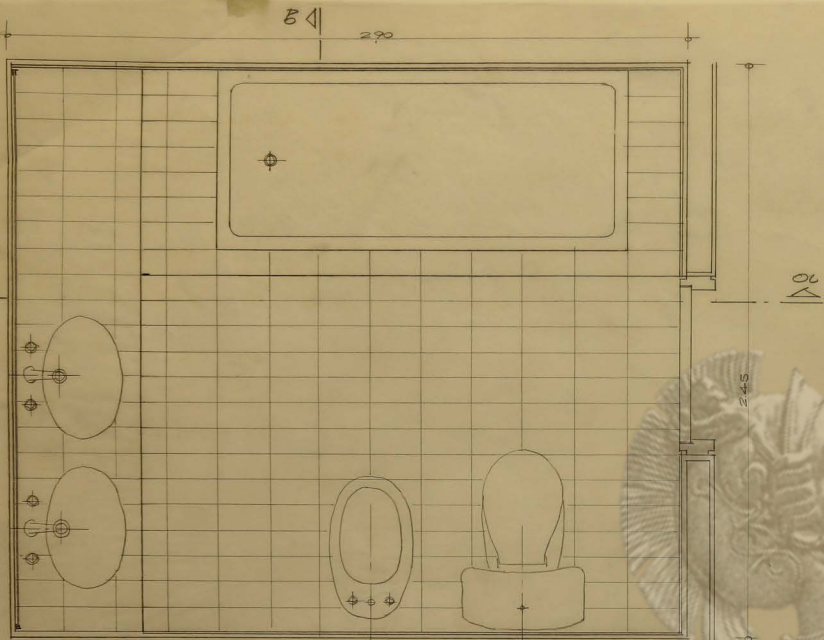

ΔΙΕΥΤΗΡΙΑ ΕΠΙΧΕΙΡΗΣΕΩΣ
 ΛΕΙΤΟΥΡΓΙΑΣ ΛΟΥΤΡΟΥ

ΕΛΙΜΑΣ 1910
 ΑΡΧΙΤΕΚΤΟΝ Ν. ΒΑΛΙΑΝΑΚΗΣ

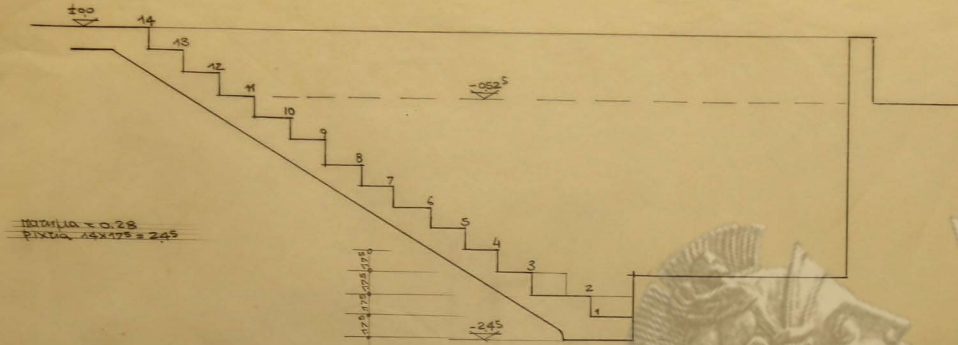

ΑΘΗΝΑΝ

Τομή α-α κλίμακας 1/20

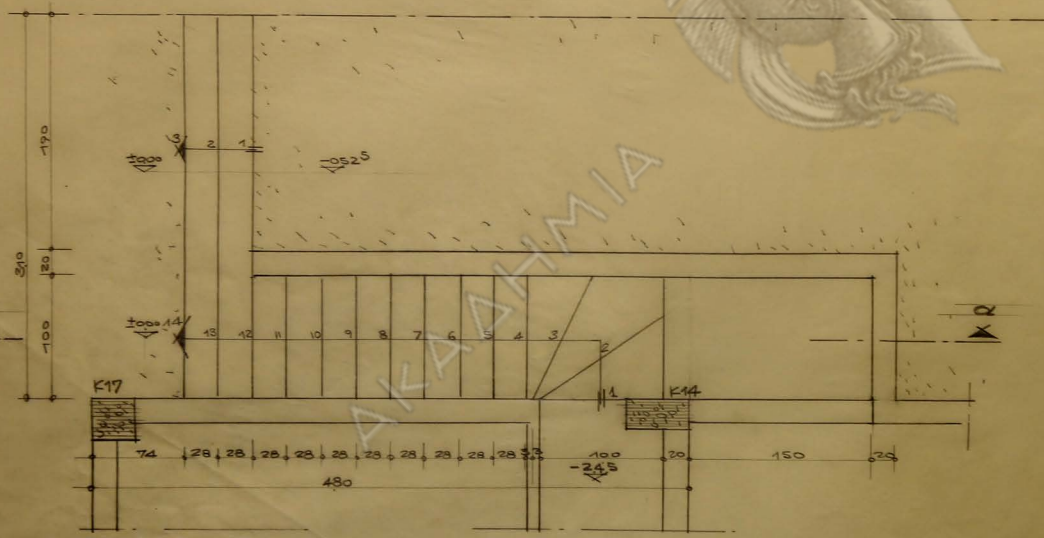
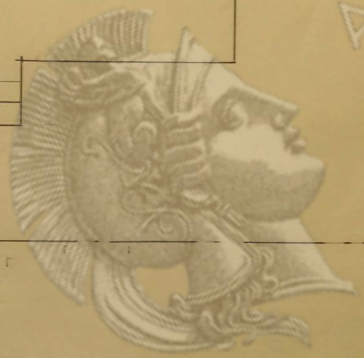

ΑΚΑΔΗΜΙΑ

ΟΙΚΙΑ ΕΠΙΣΤΟΛΟΤΑΡΙΟΥ
 ΛΕΩΝΗ ΕΞΟΥ, ΚΑΙΜΑΡΟΣ
 ΚΑΙΜΑΡ 1/20
 ΑΡΧΙΤΕΚΤΟΝΙ Ν. ΒΑΣΙΛΑΧΑΚΗ

Κατοβίς κλίμακας 1/20

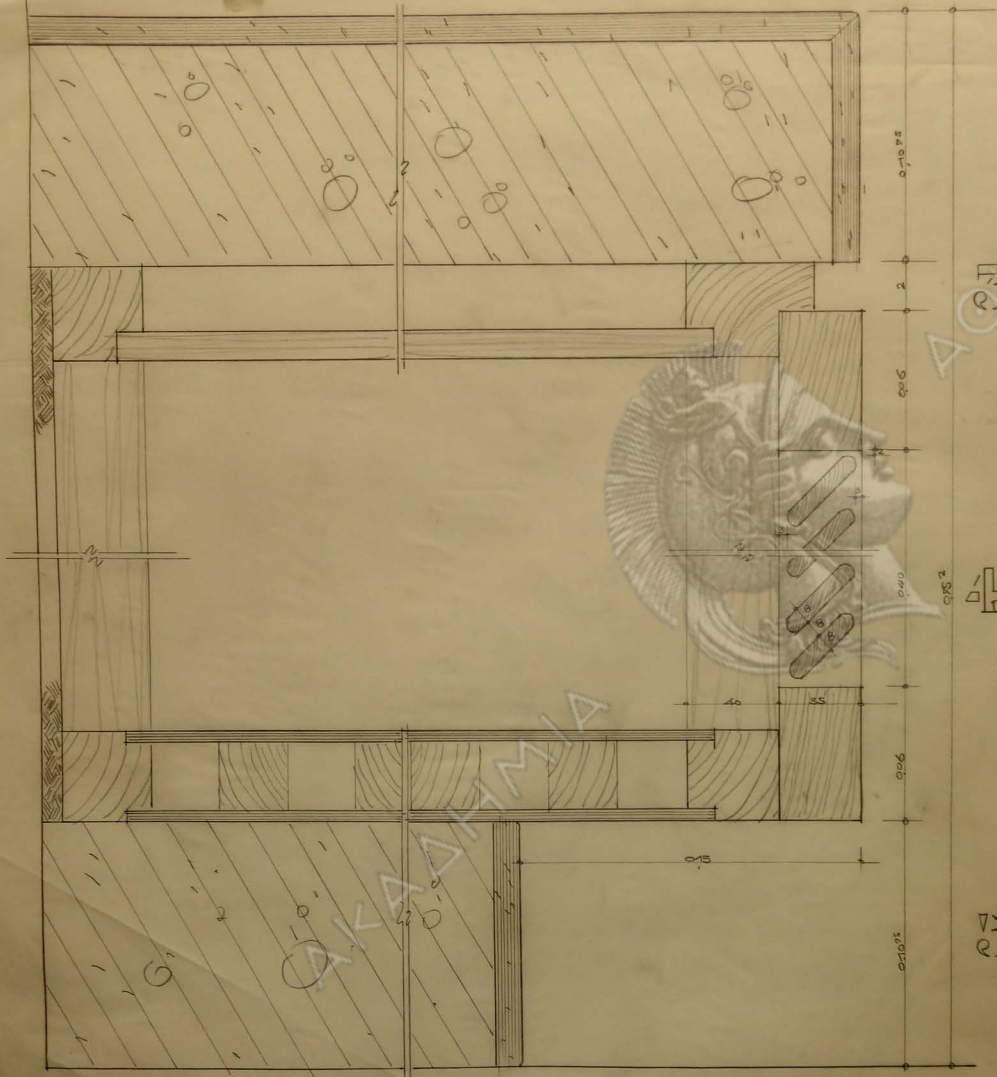

ΚΑΤΑ ΚΟΡΥΦΗ ΤΟΜΗ

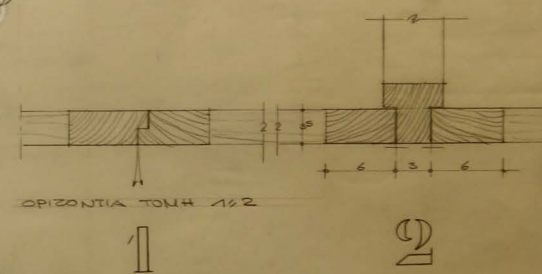

ΟΡΙΖΟΝΤΙΑ ΤΟΜΗ 1/2

ΣΚΙΑ ΕΠΙΣΤΟΙΧΟΤΑΠΙΣ
ΛΕΠΤΟΜΕΡΗΤΑΙ ΔΟΥΤΡΩΝ

ΚΑΙΝΑΣ 1/1 1/2
ΑΡΧΙΤΕΚΤΟΝ Ν. ΒΑΛΙΑΝΑΚΗΣ

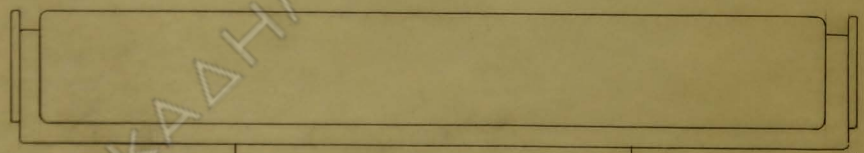
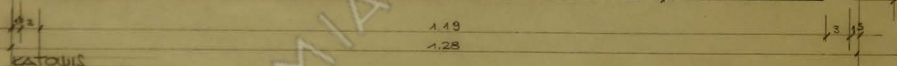
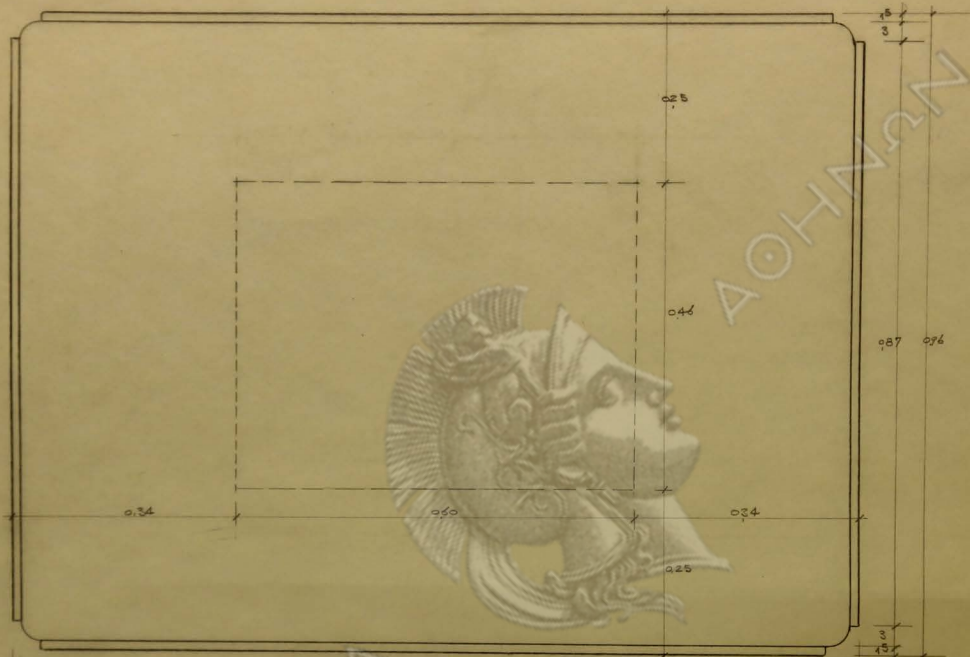

0013

ΕΙΜΑΕ 1/5

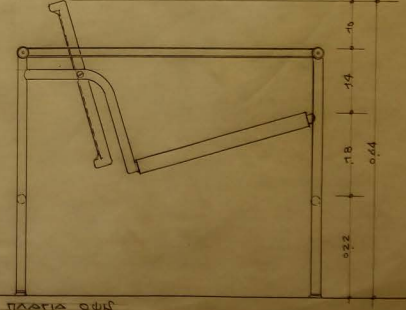
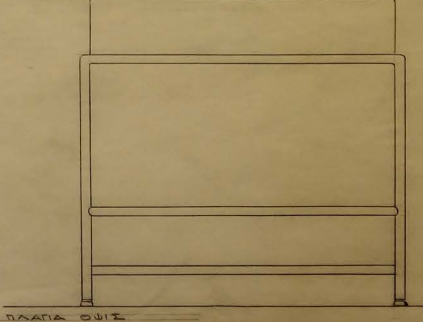
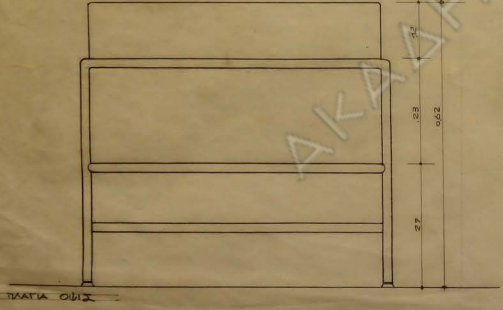
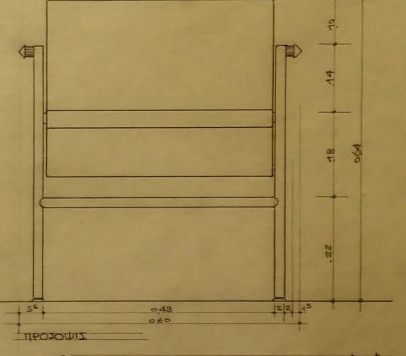
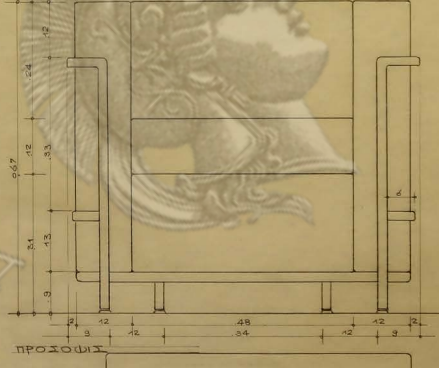
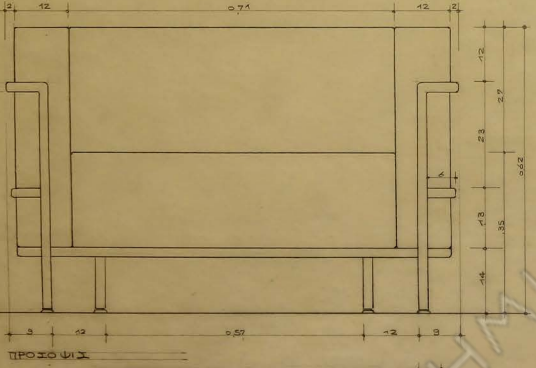
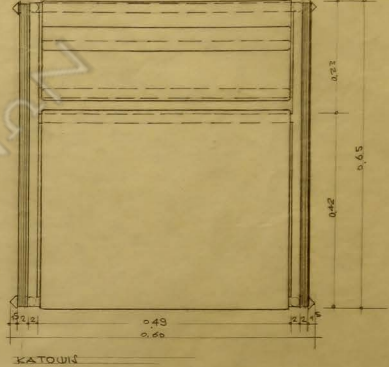
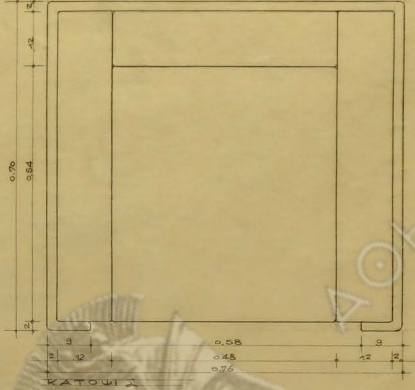
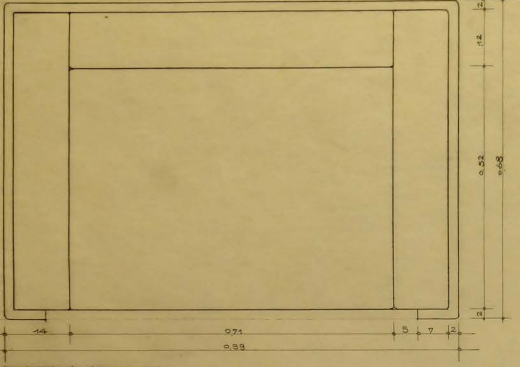

230 B

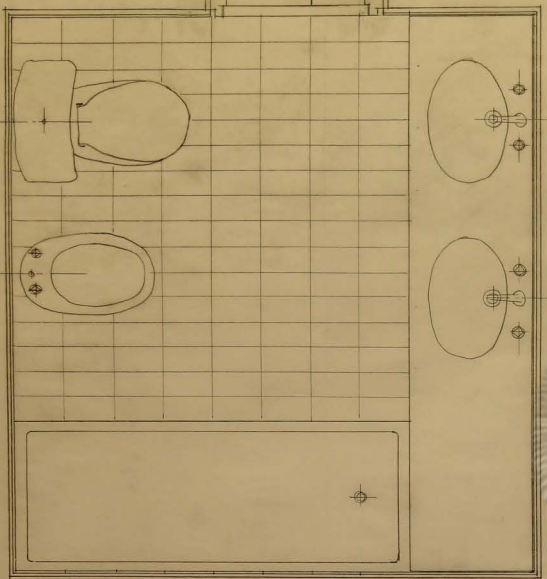

245

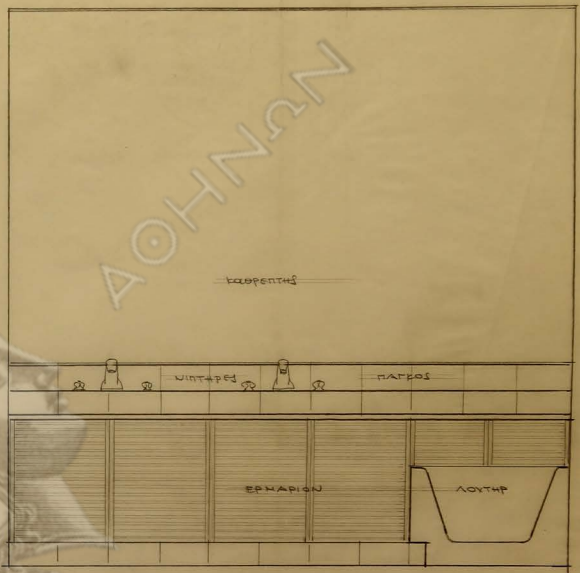

τομή Β-Β

A-A

κατάν

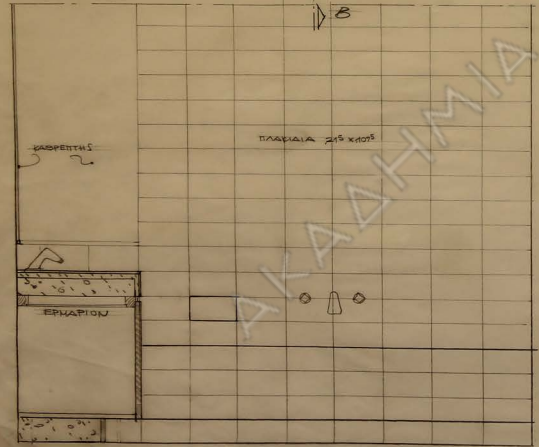

τομή Α-Α

ΑΚΑΔΗΜΙΑ

ΔΙΚΤΑ ΕΠΙΣΤΟΜΟΤΑΡΙΤ
ΧΕΙΤΟΜΕΡΕΙΑ ΛΟΥΤΡΟΥ

ΕΤΙΜΑΕ 1940
ΑΡΧΙΤΕΚΤΟΝ Ο ΒΑΣΙΛΑΧΑΚΗΣ