

1:10

1:1

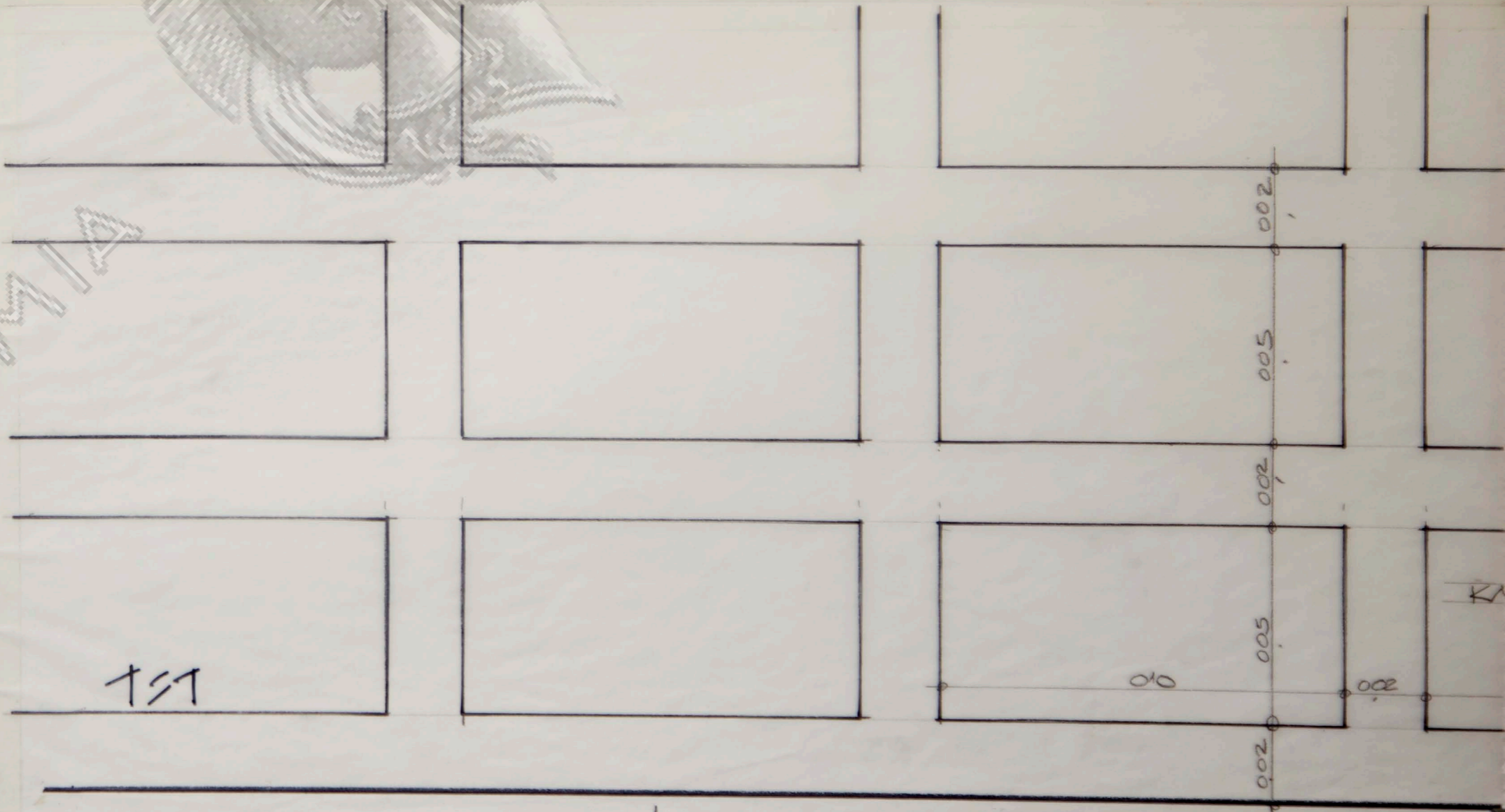

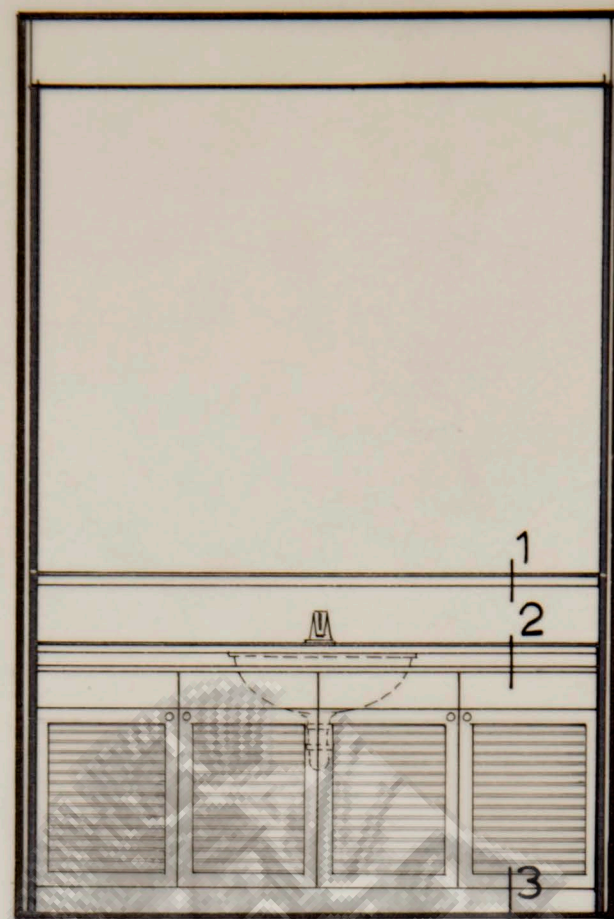
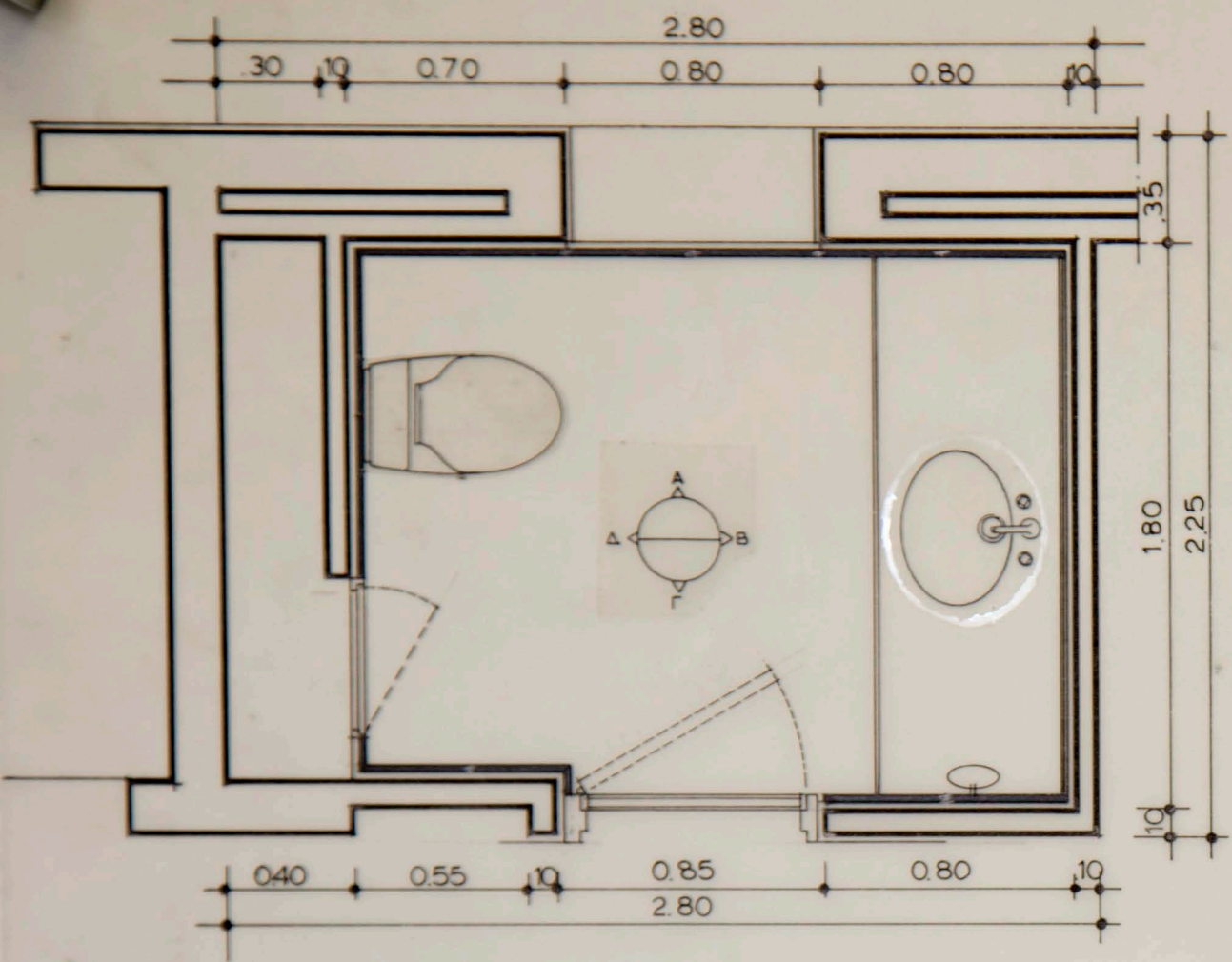

ΟΨΗ "Β"

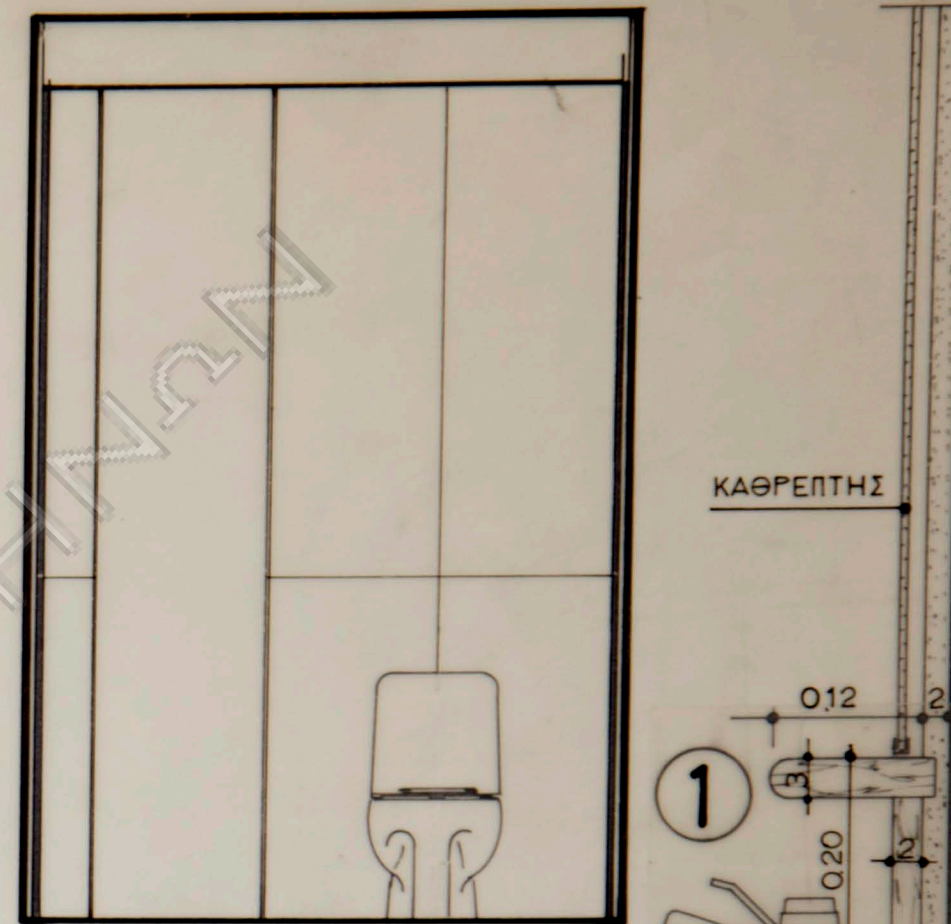

ΟΨΗ "Δ"



ΟΨΗ "Α"

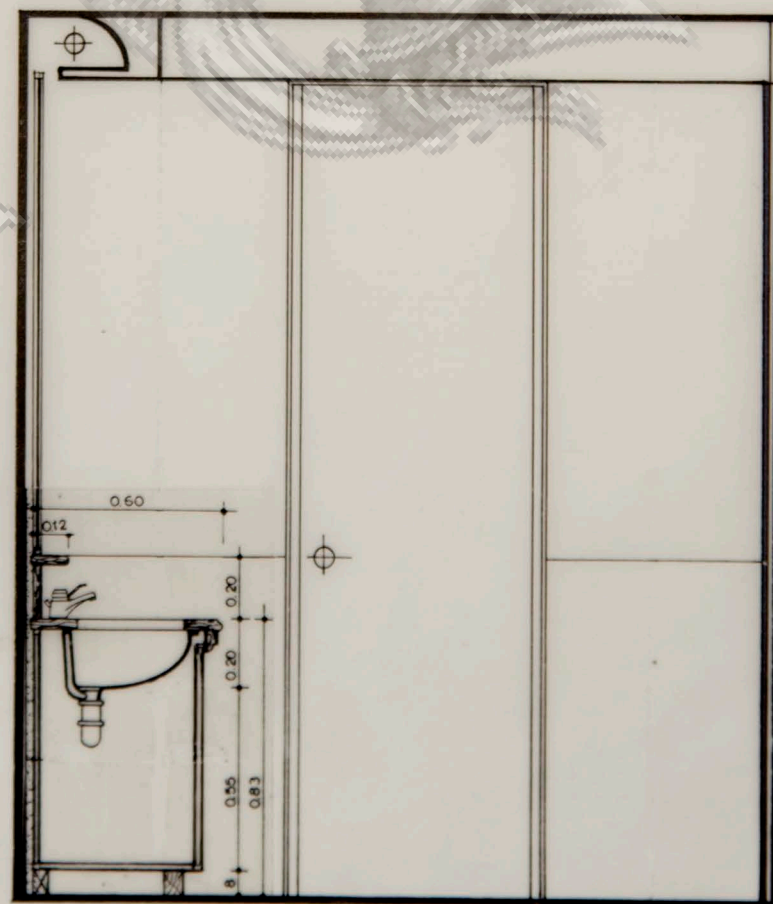

ΟΨΗ "Γ"

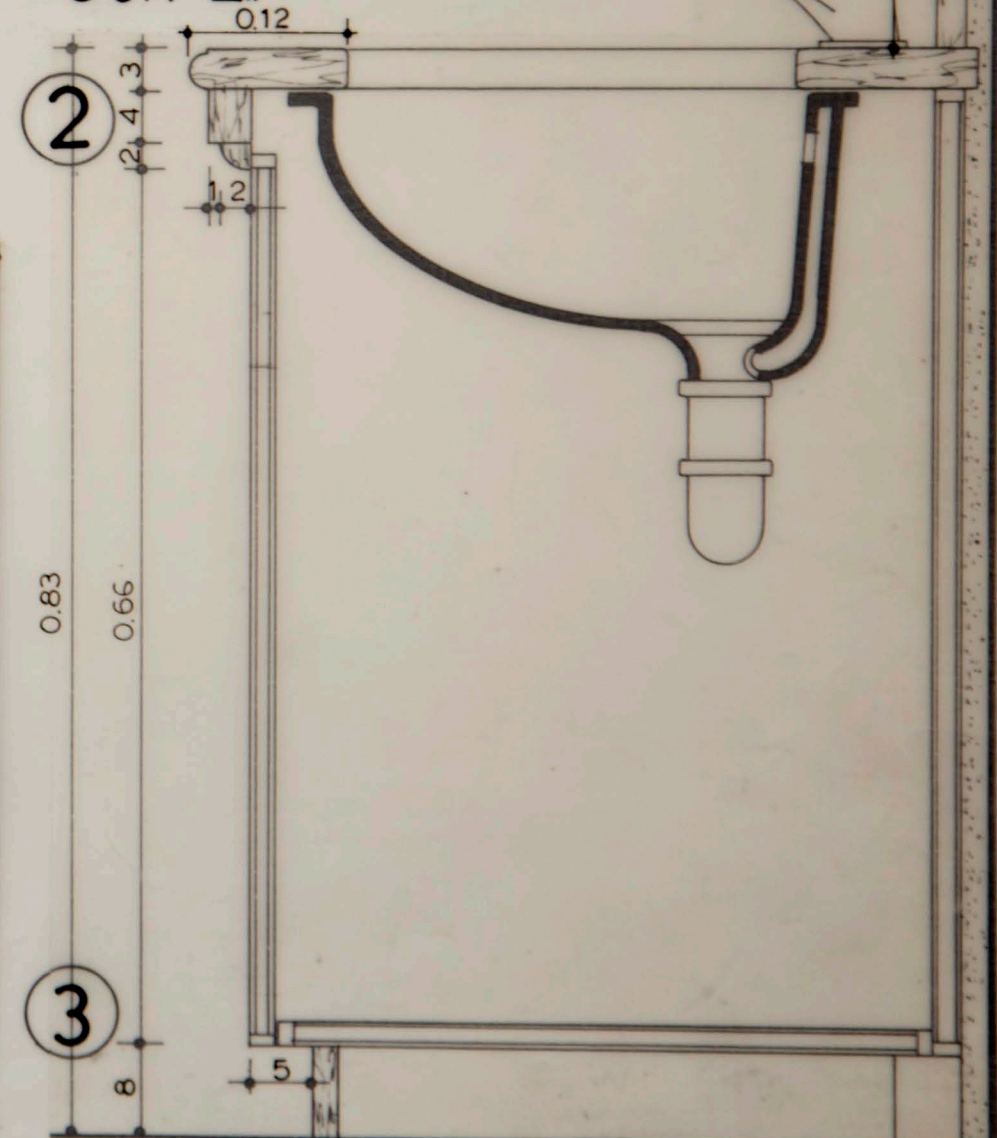

ΛΕΠΤ. ΚΛ. 1:5

W.C. ΞΕΝΩΝ ΙΣΟΓΕΙΟΥ
ΚΛΙΜΑΞ 1:20

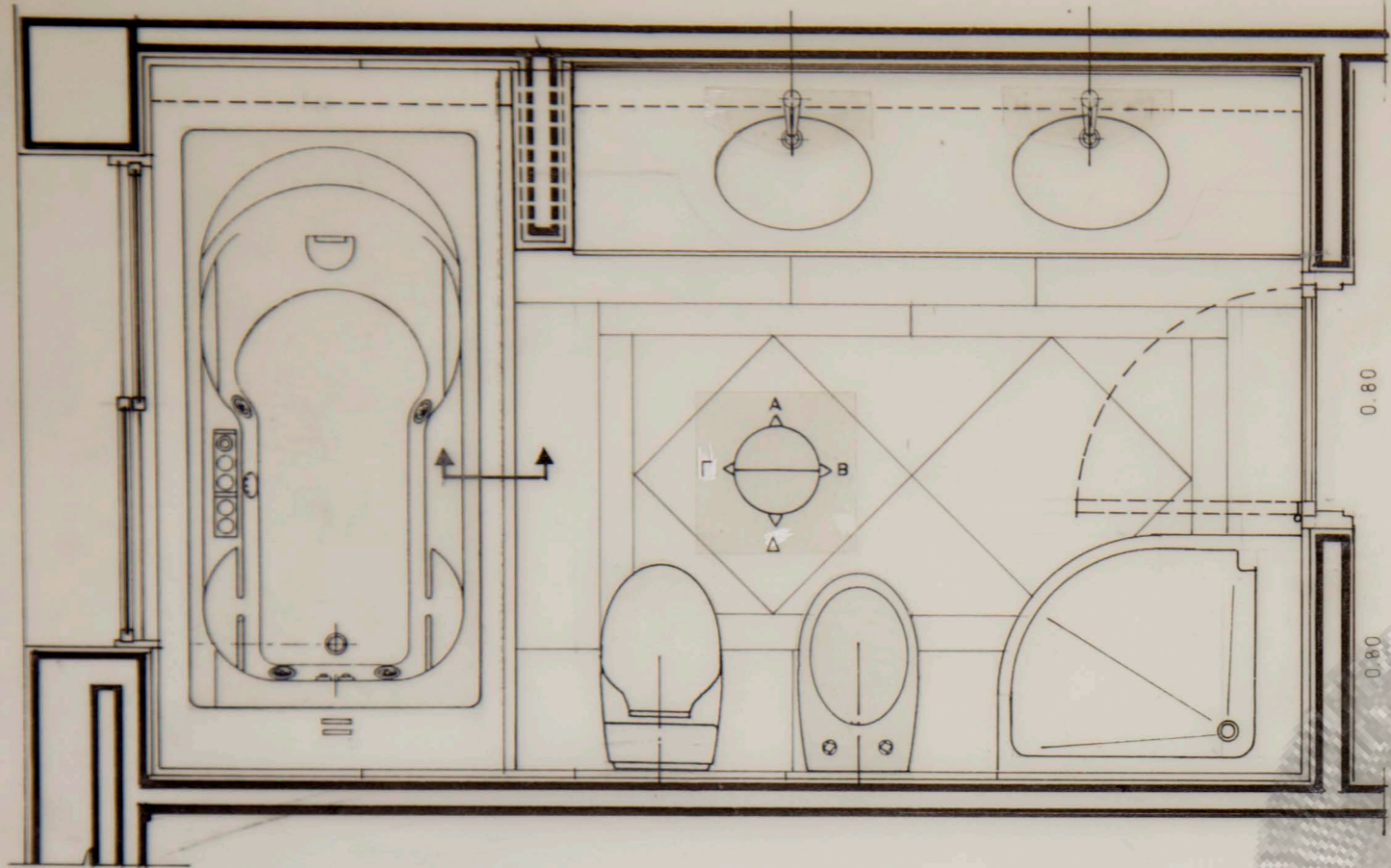

ΚΑΤΩΨΗ 1:20

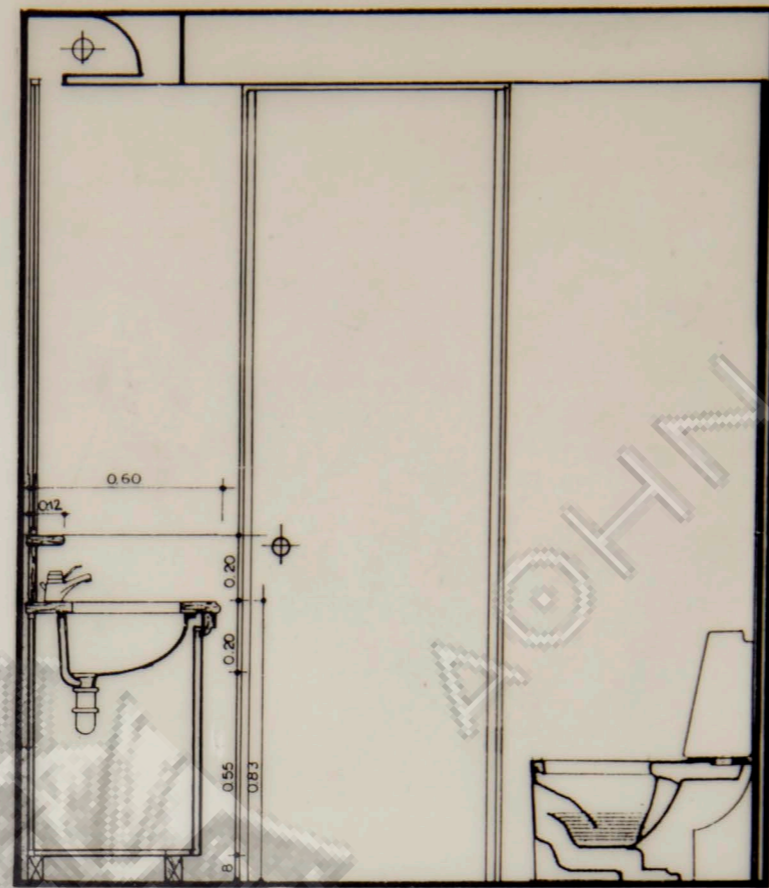

ΟΨΗ "B"

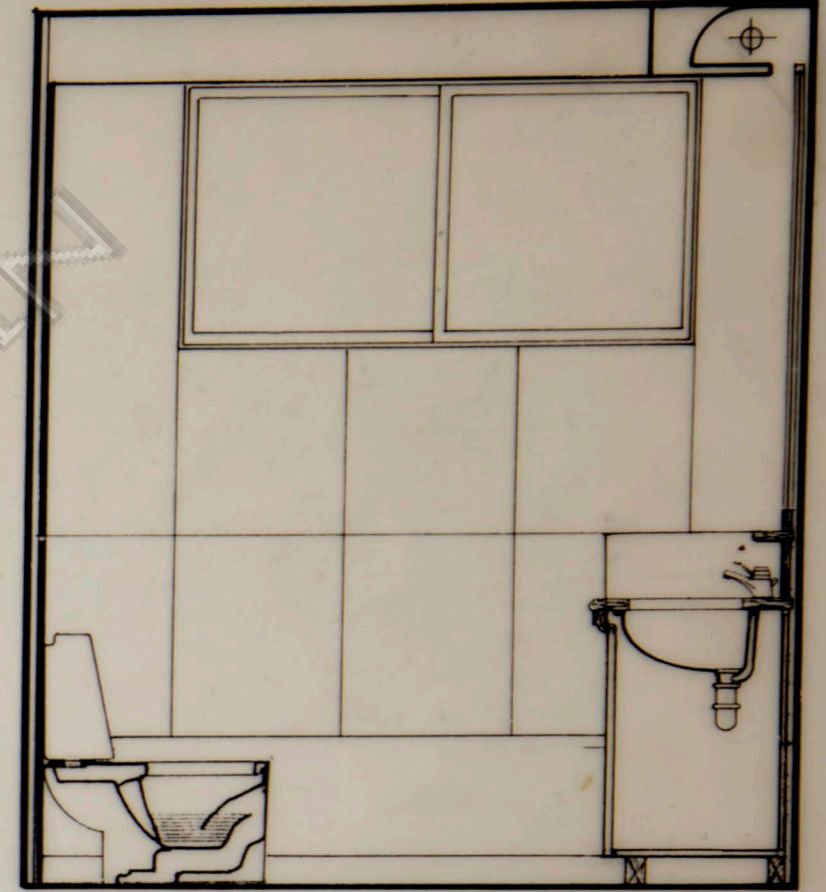

ΟΨΗ "Γ"

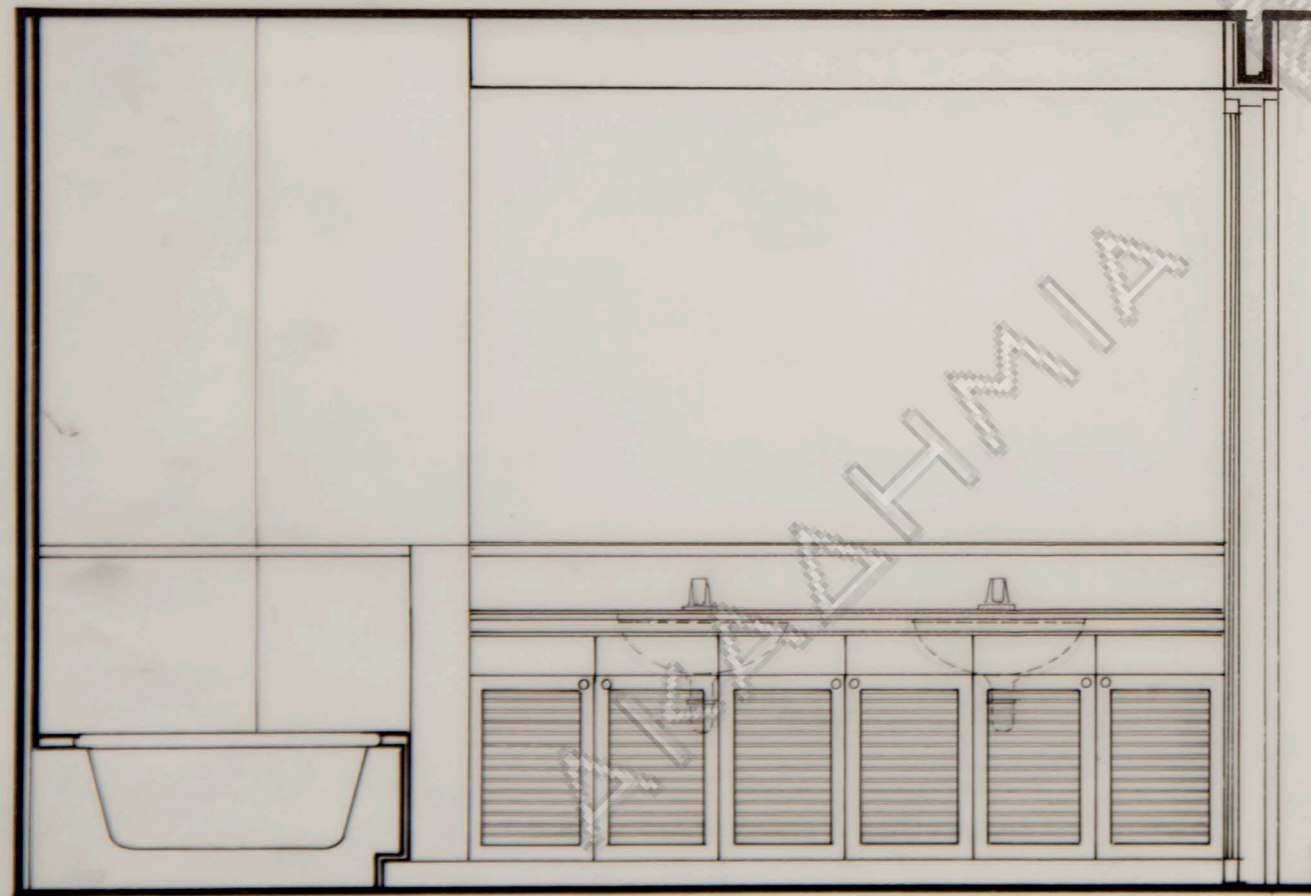

ΟΨΗ "A"



ΟΨΗ "Δ"

ΛΟΥΤΡΟ Α'ΟΡΟΦΟΥ
ΚΛΙΜΑΞ 1:20

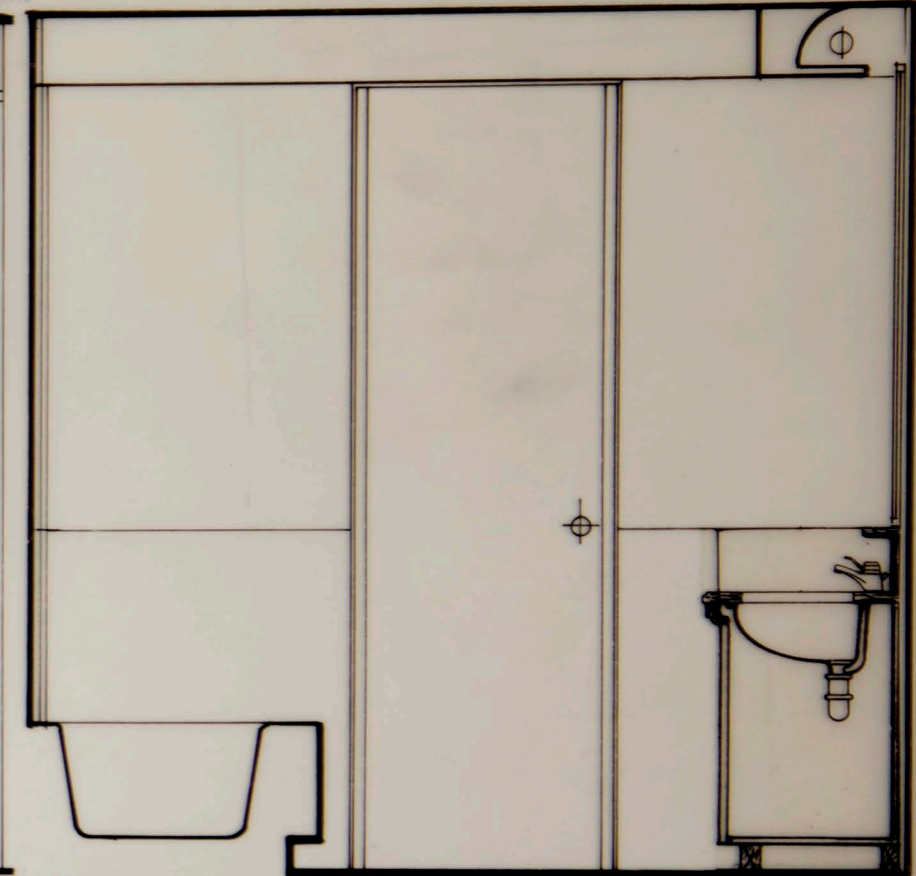
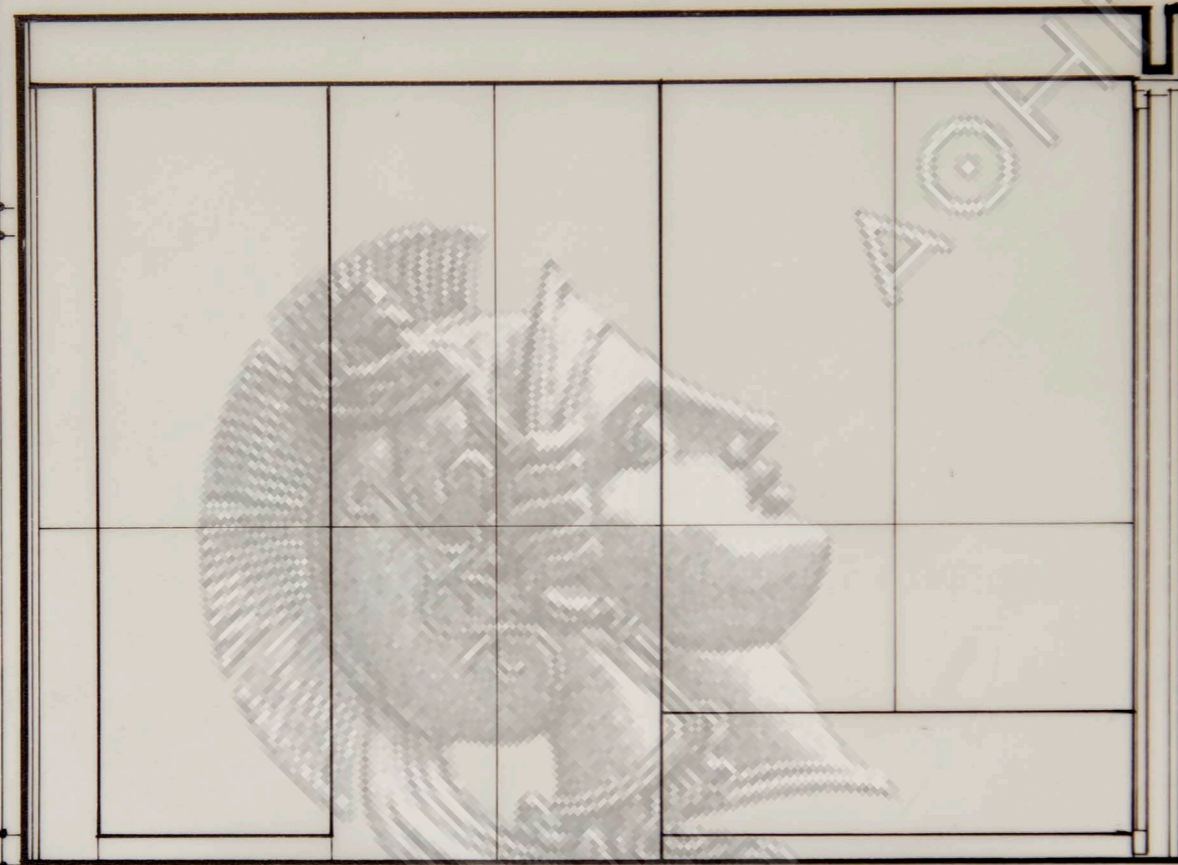
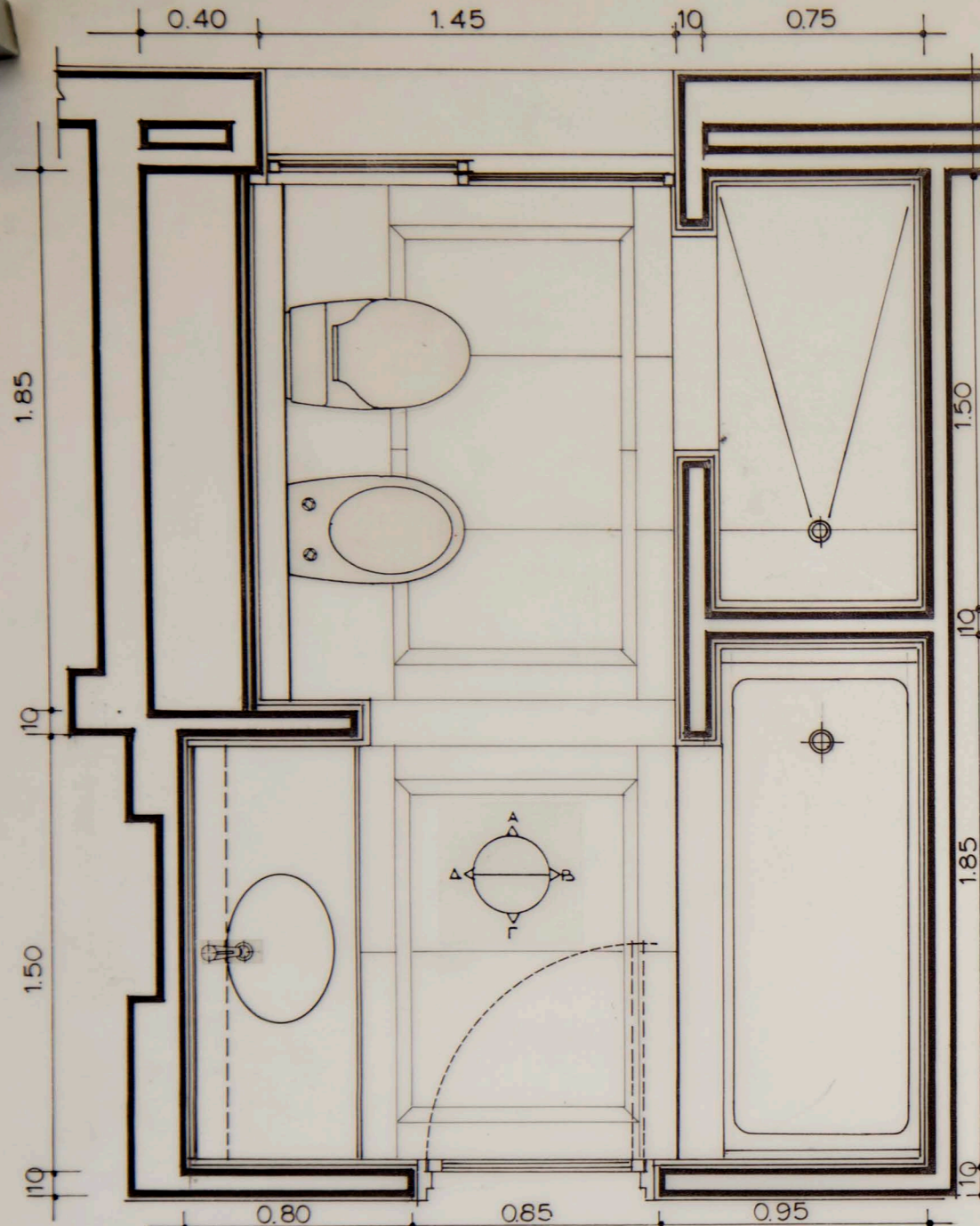

ΟΨΗ "Β,"

ΟΨΗ "Γ,"

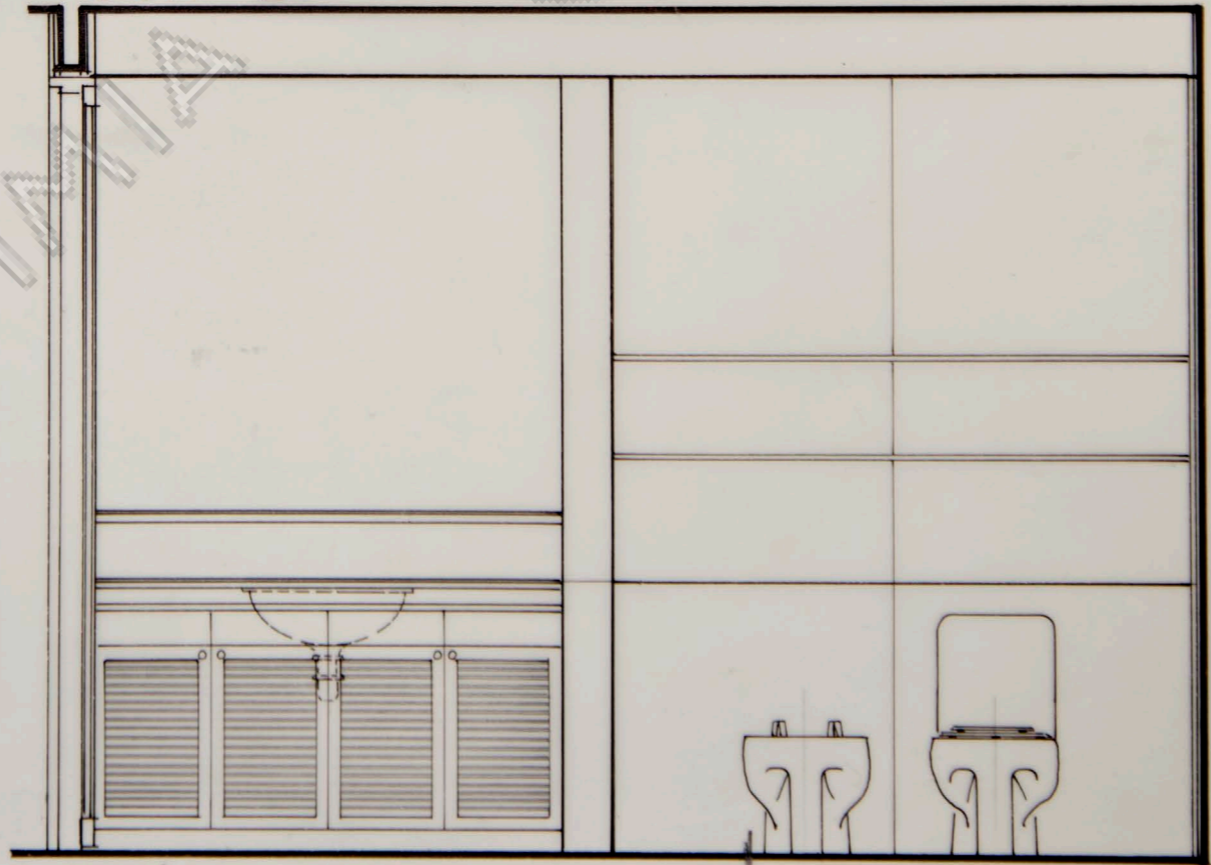
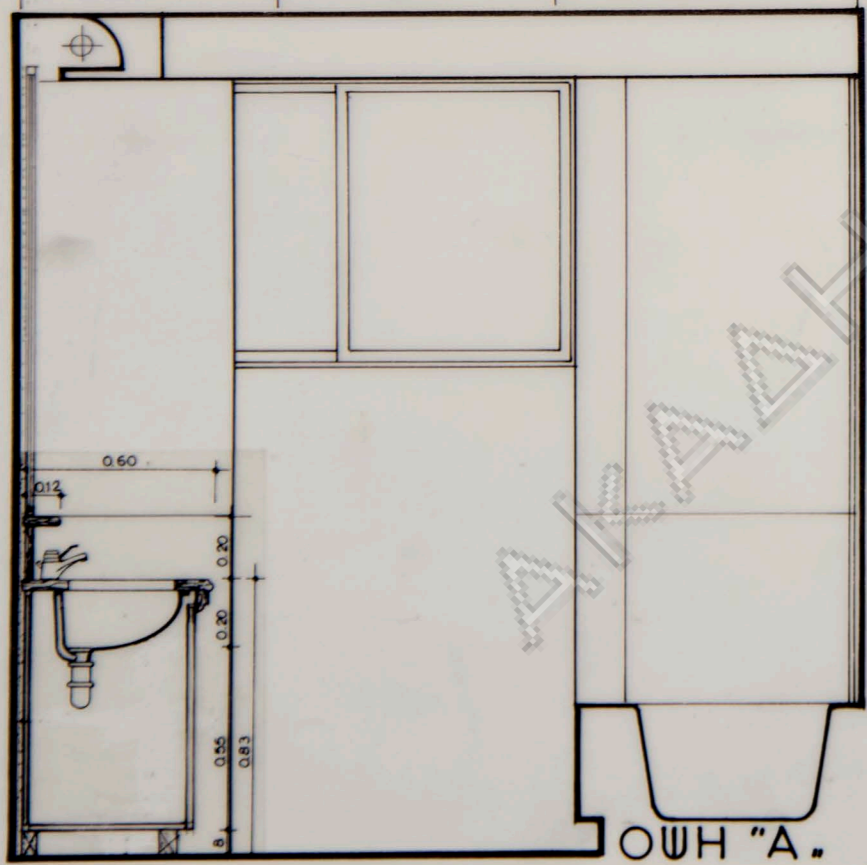

ΟΨΗ "Α,"

ΟΨΗ "Δ,"

ΛΟΥΤΡΟ Α' ΟΡΟΦΟΥ
ΚΛΙΜΑΞ 1:20

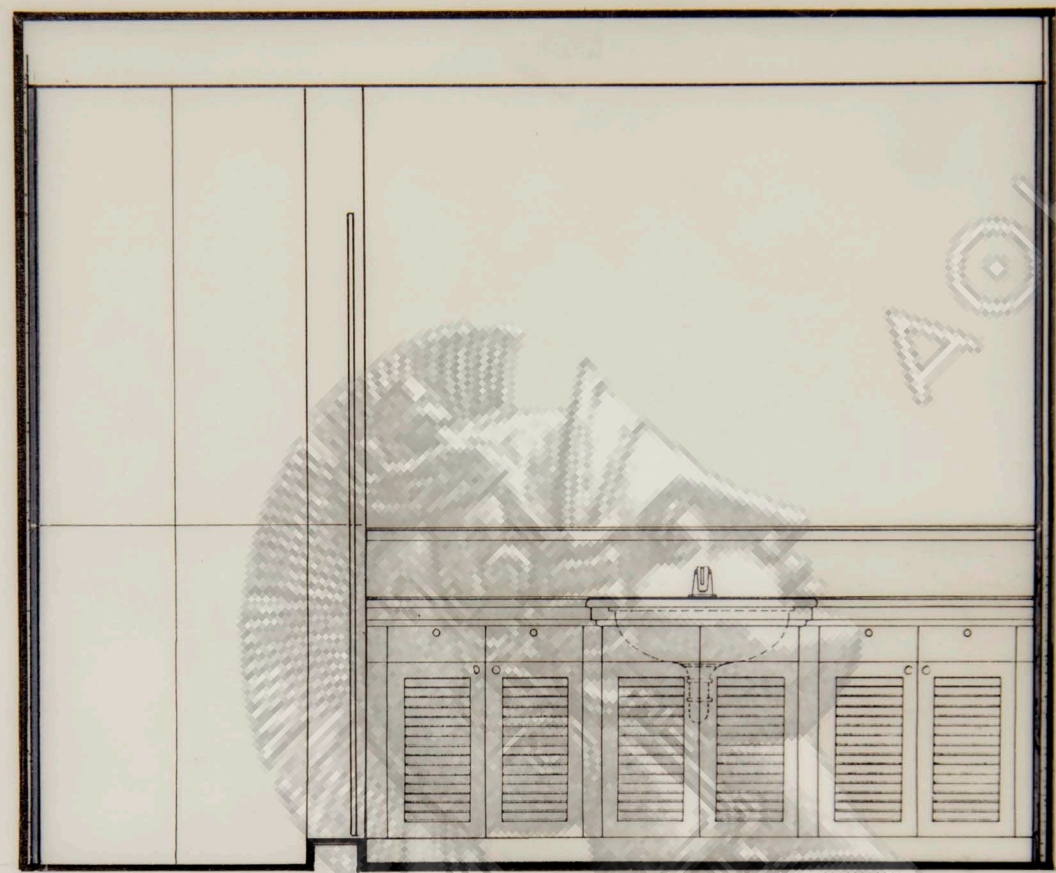
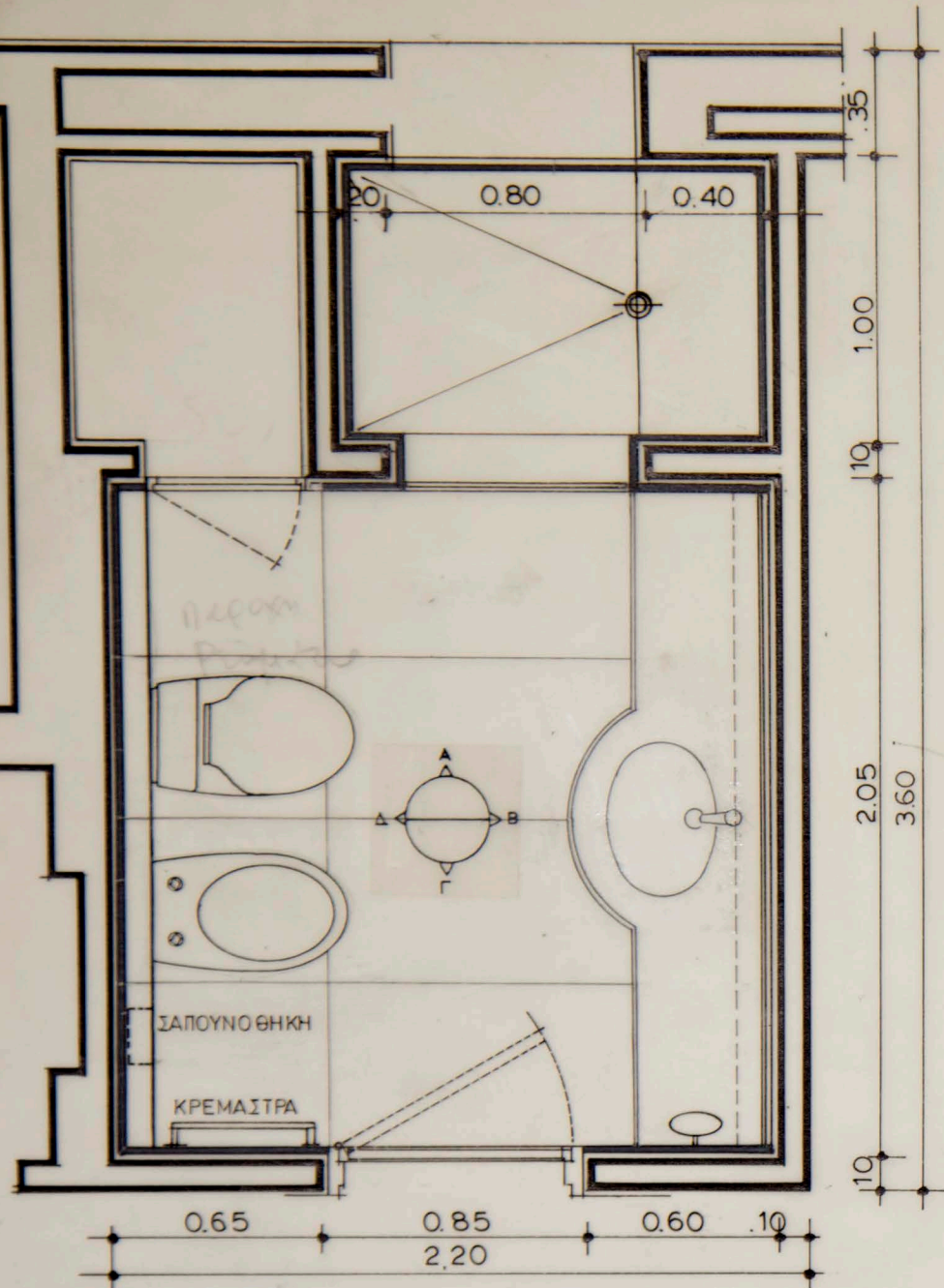

ΟΨΗ "Β"

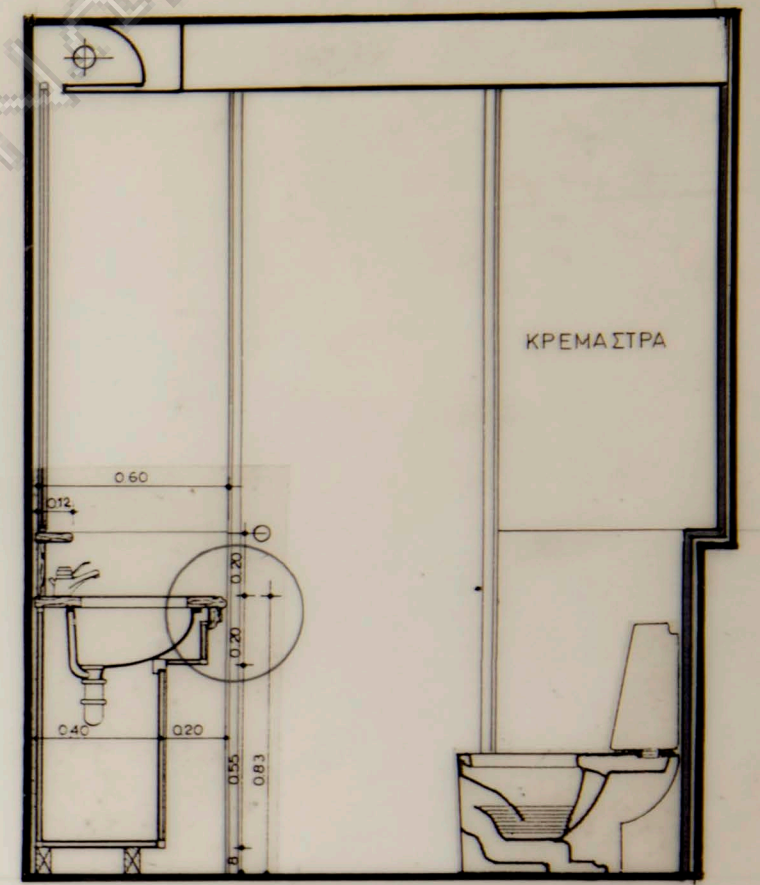

ΟΨΗ "Γ"



ΟΨΗ "Α"

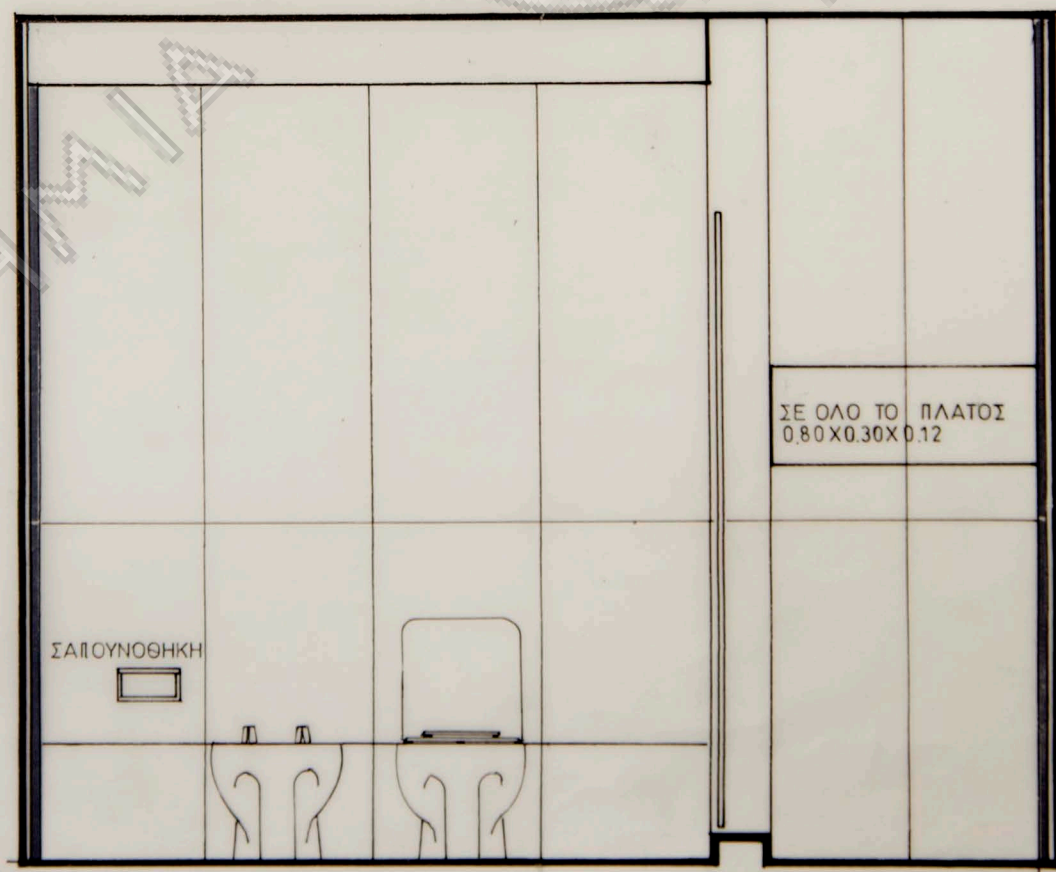

ΟΨΗ "Δ"

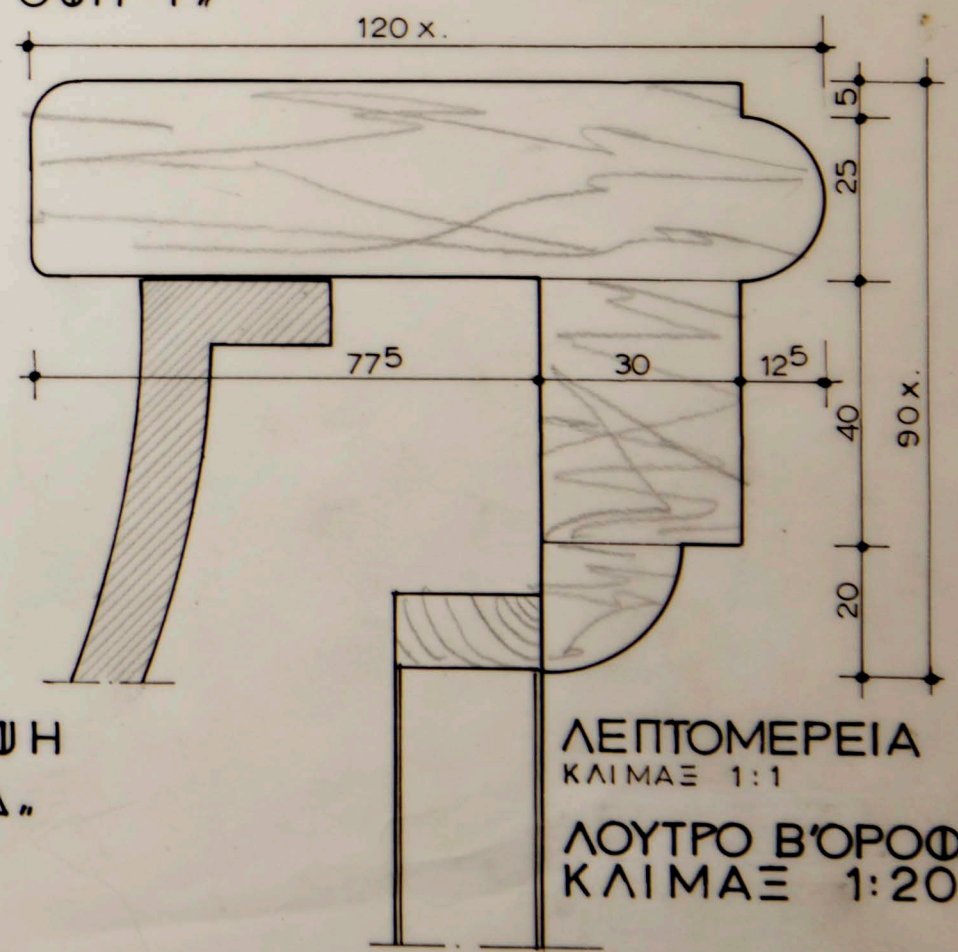

ΛΕΠΤΟΜΕΡΕΙΑ ΚΛΙΜΑΞ 1:1
ΛΟΥΤΡΟ Β'ΟΡΟΦ ΚΛΙΜΑΞ 1:20

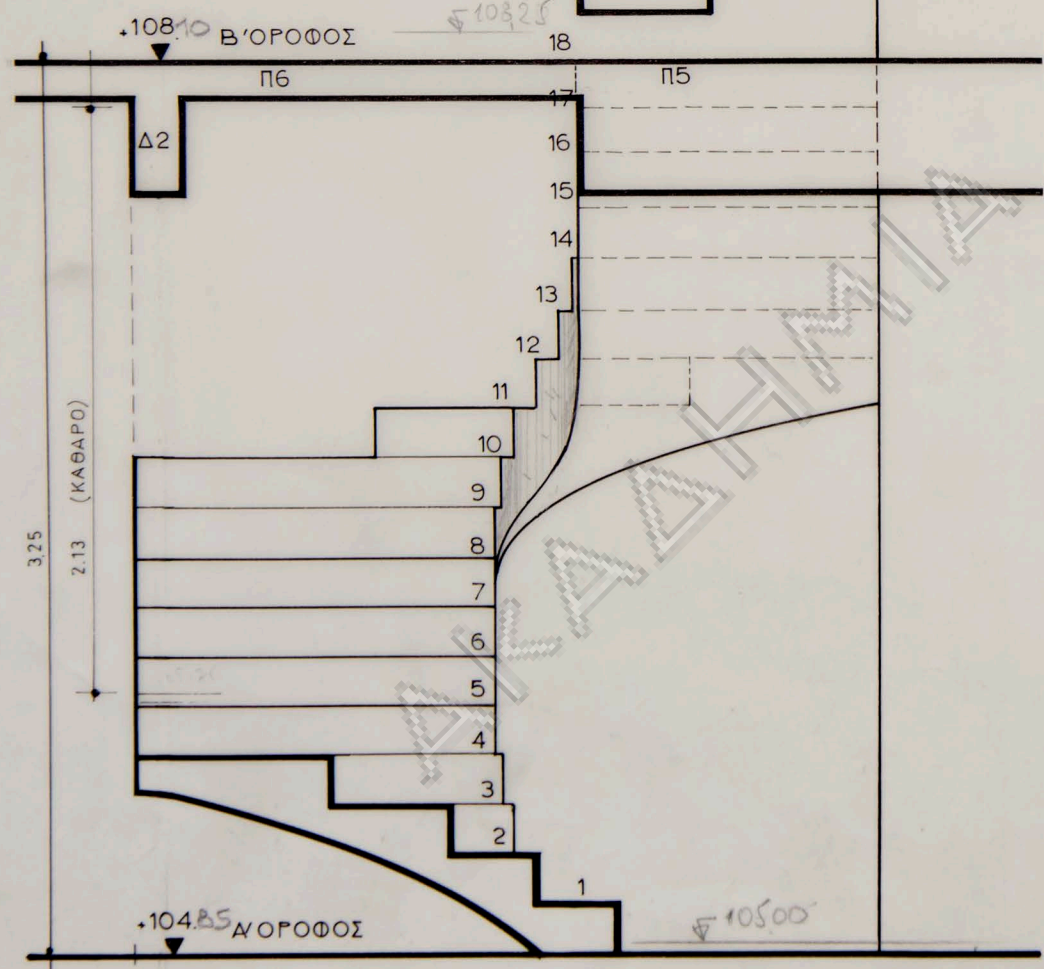
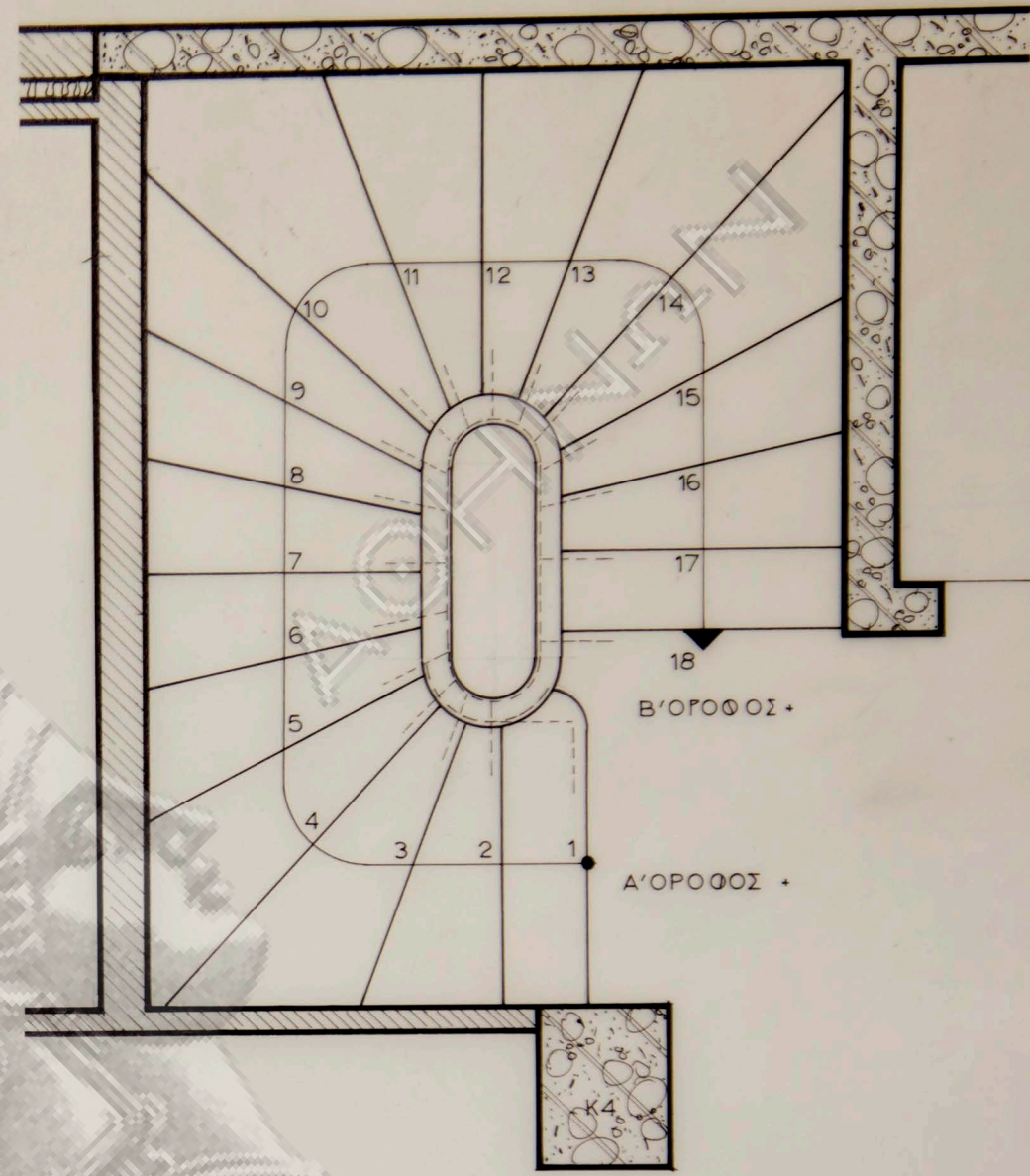
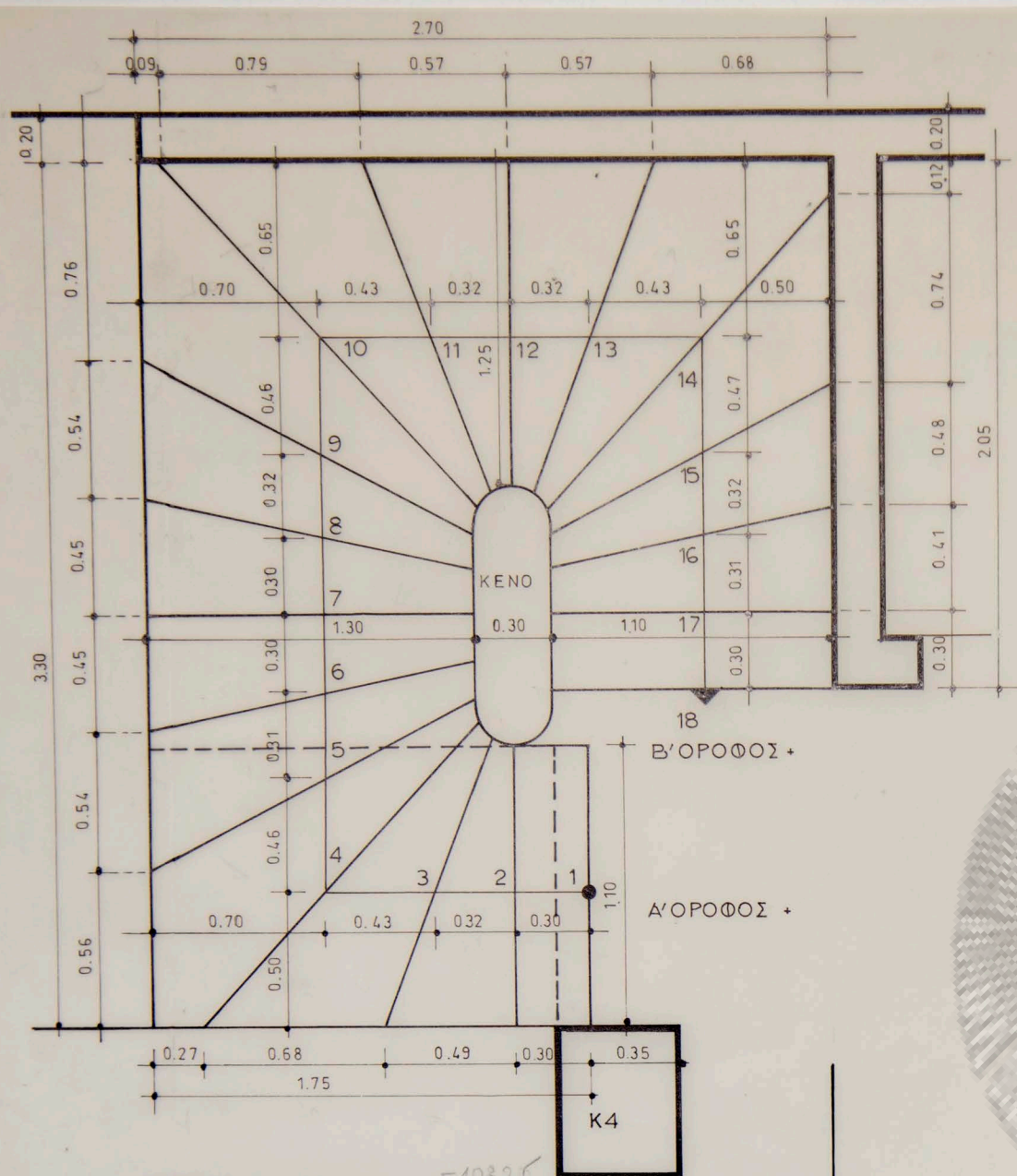

ΣΚΑΛΑ ΑΠΟ Α'ΟΡΟΦΟ ΣΤΟΝ Β'ΟΡΟΦΟ
ΚΛ. 1:20

ΠΑΤΗΜΑ = 0.30
ΡΙΧΤΙΑ = 18x0.18 = 3.25 m.

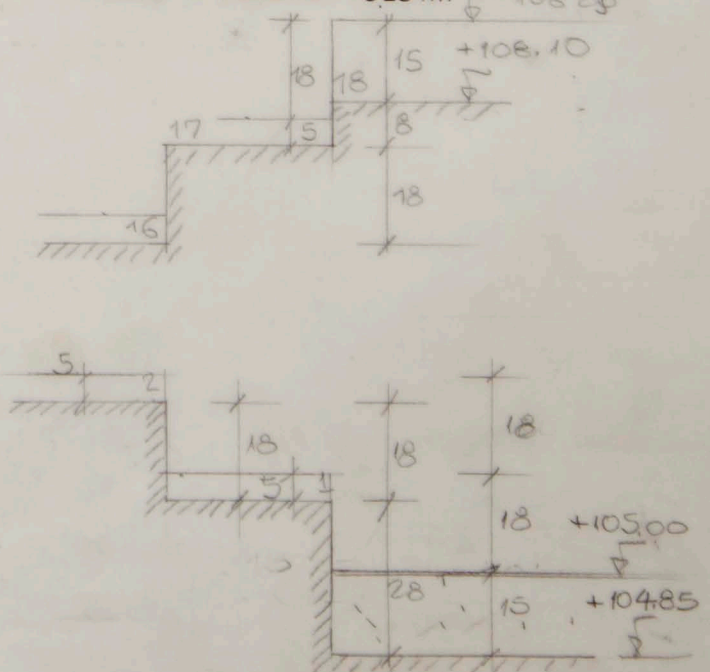

ΟΙΚΙΑ ΣΤΕΦ. ΖΑΧΑΡΙΑΔΗ
ΕΠΙ ΤΩΝ ΟΔΩΝ ΕΥΡΥΔΙΚΗΣ
ΚΑΙ ΤΕΡΨΙΧΟΡΗΣ-ΒΟΥΛΙΑΓΜΕΝΗ

ΑΡΧΙΤΕΚΤΩΝ: Ν. ΒΑΛΣΑΜΑΚΗΣ

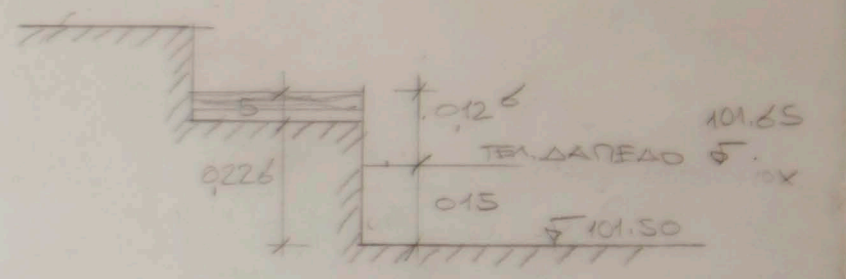
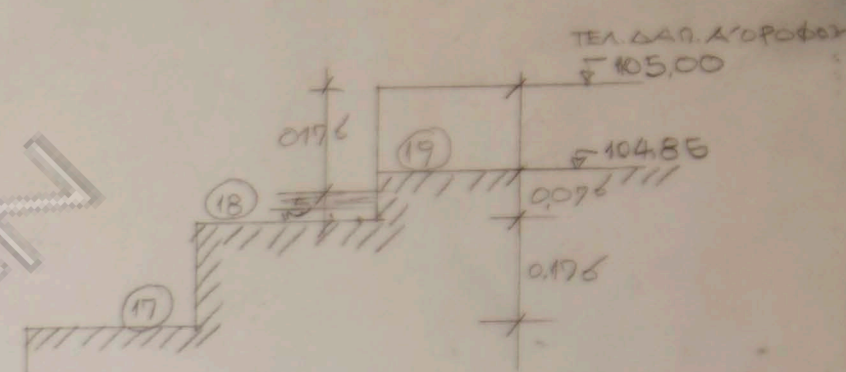
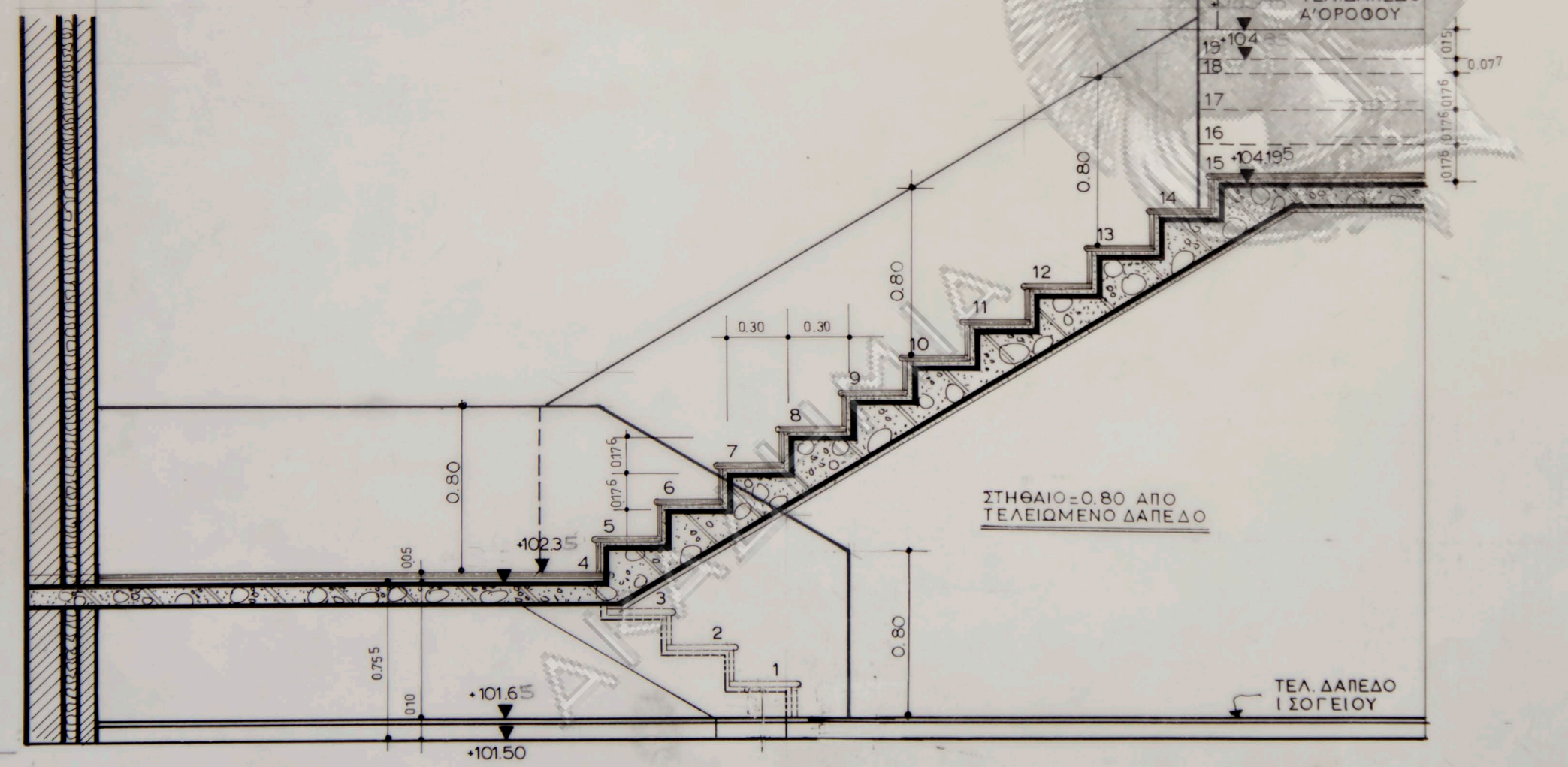
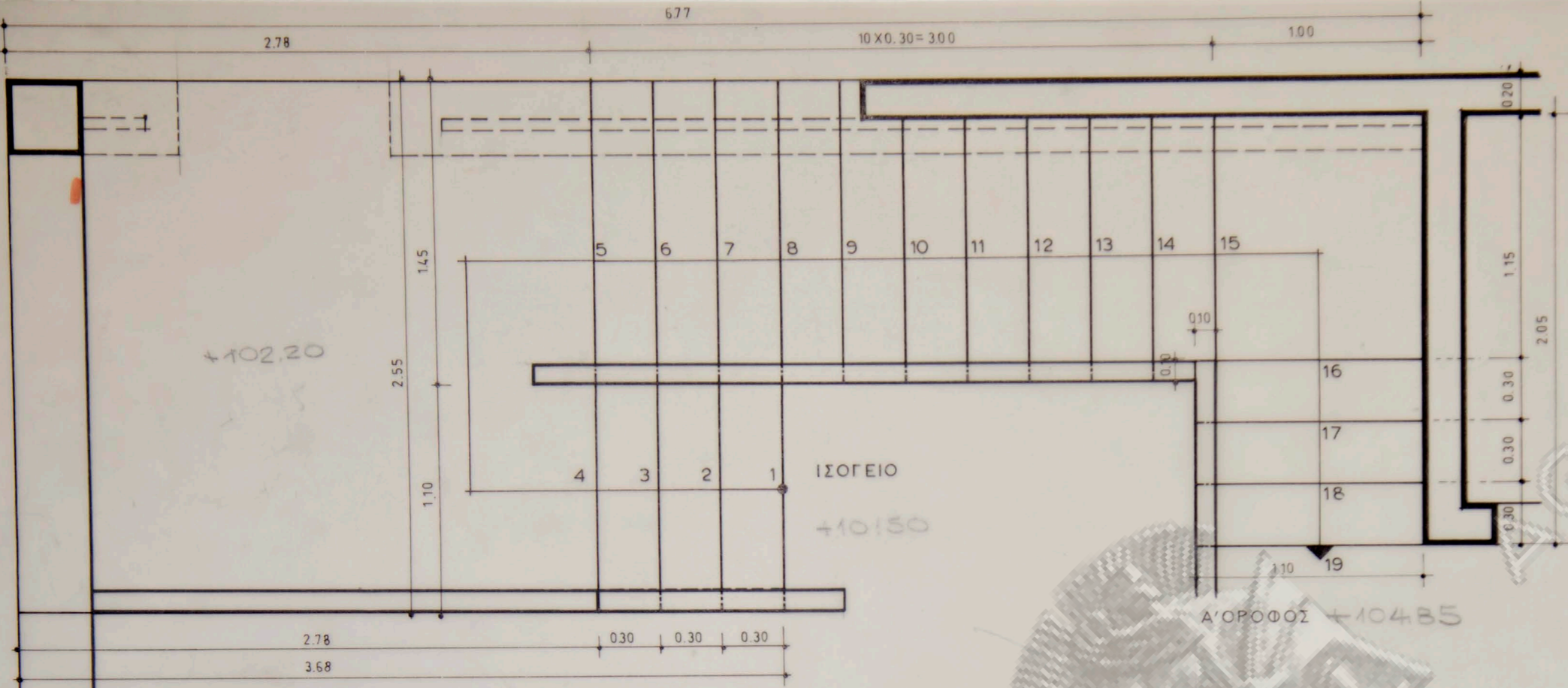

ΟΙΚΙΑ ΣΤΕΦ. ΖΑΧΑΡΙΑΔΗ
ΕΠΙ ΤΩΝ ΟΔΩΝ ΕΥΡΥΔΙΚΗΣ
ΚΑΙ ΤΕΡΨΙΧΟΡΗΣ-ΒΟΥΛΙΑΓΜΕΝΗ
ΑΡΧΙΤΕΚΤΩΝ: Ν. ΒΑΛΣΑΜΑΚΗΣ

856718

ΛΕΠΤ. ΘΥΡΑΣ
ΚΛΙΜΑΞ 1:1

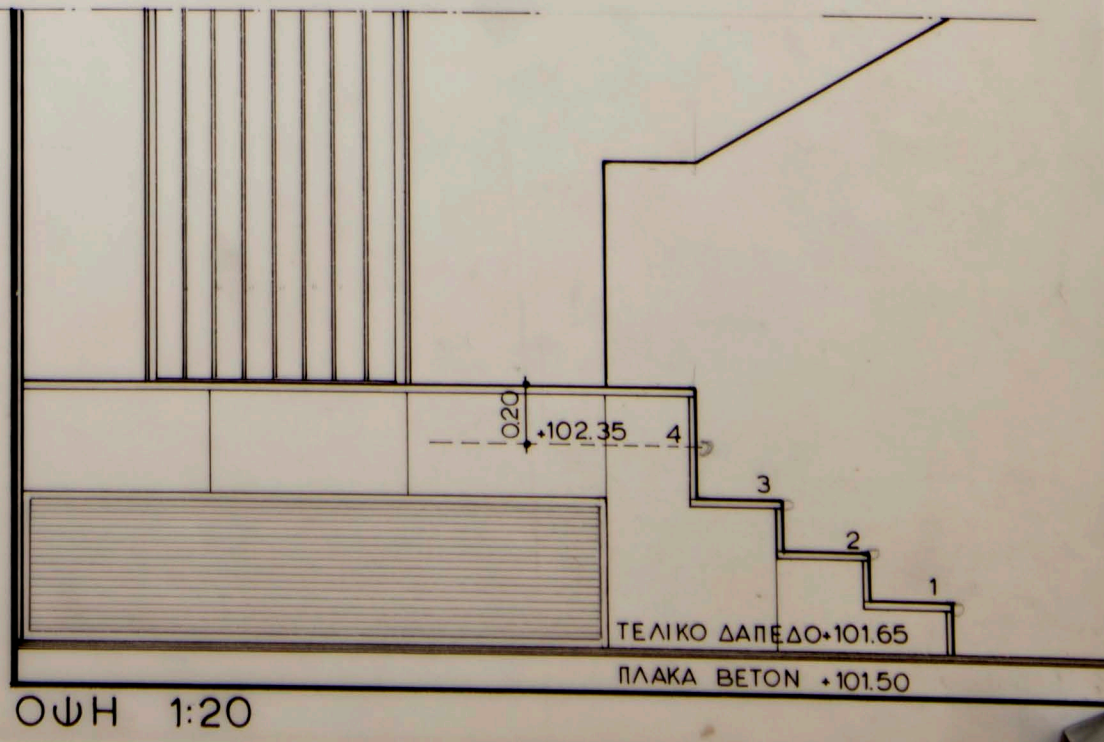
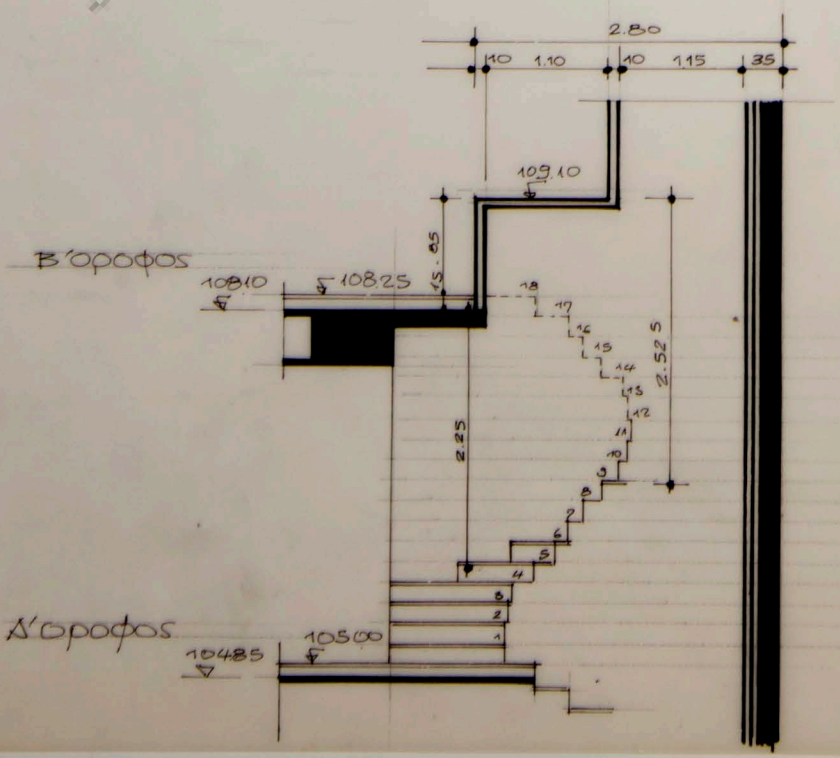
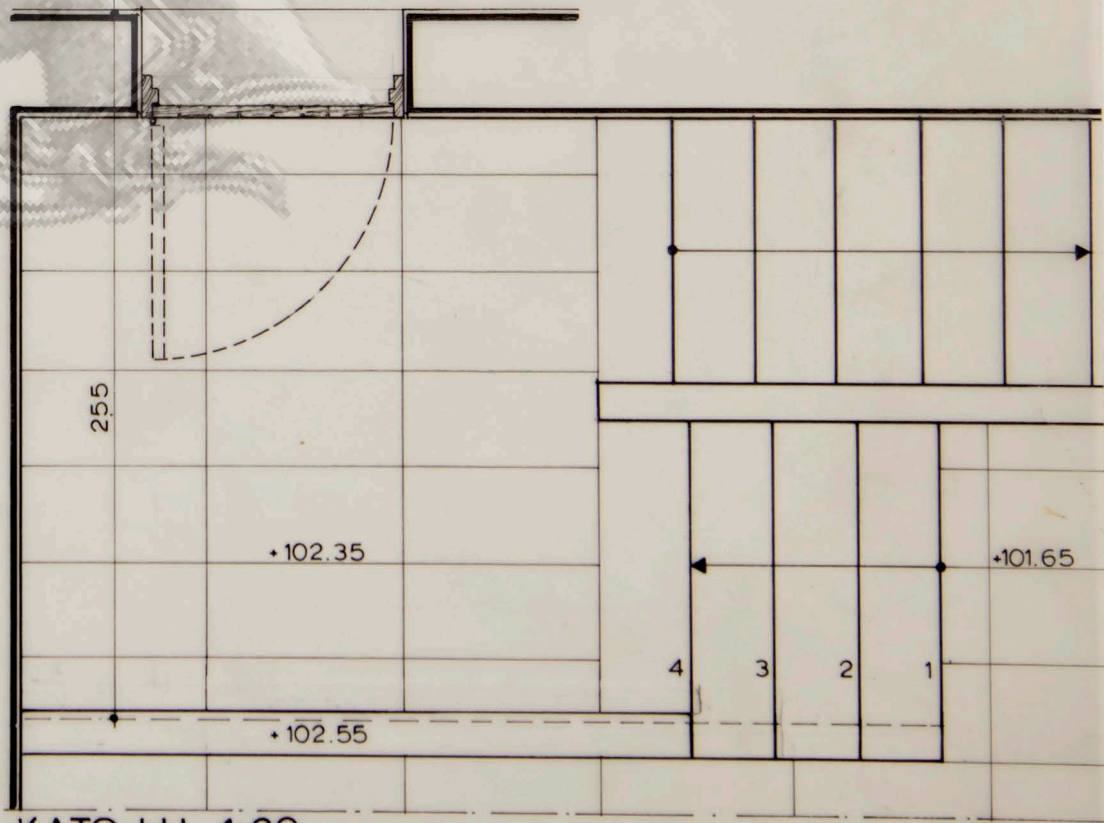
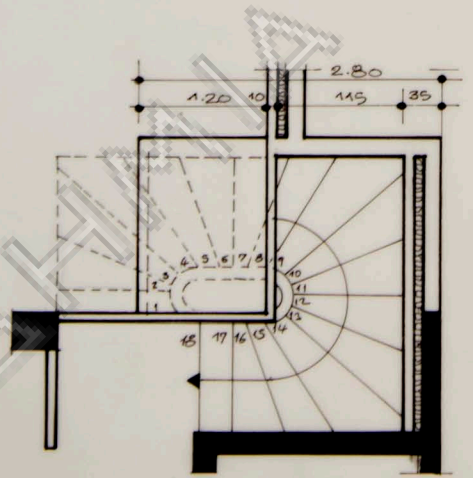
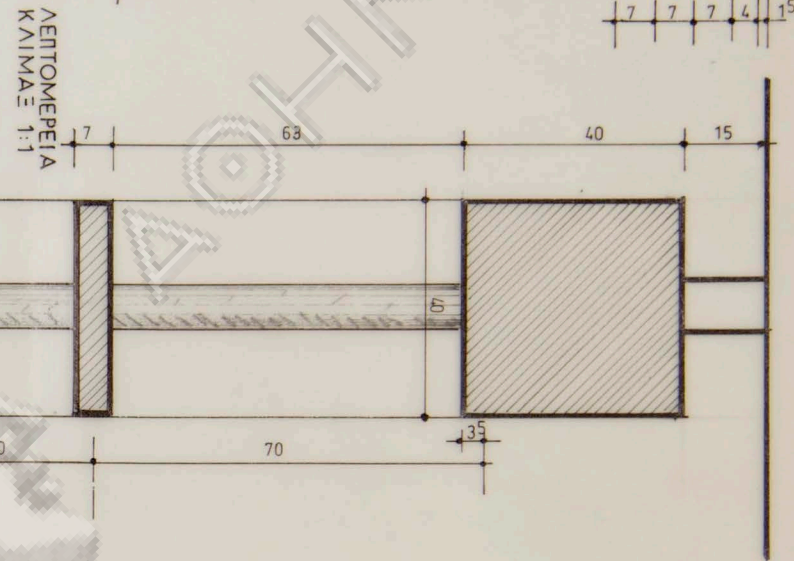
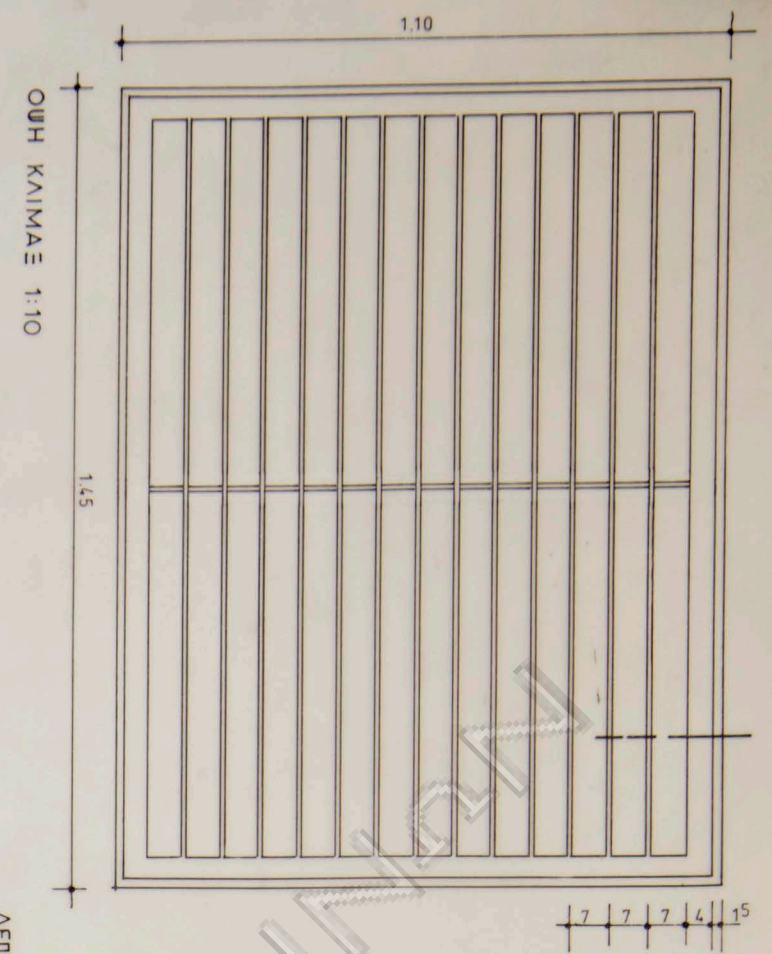
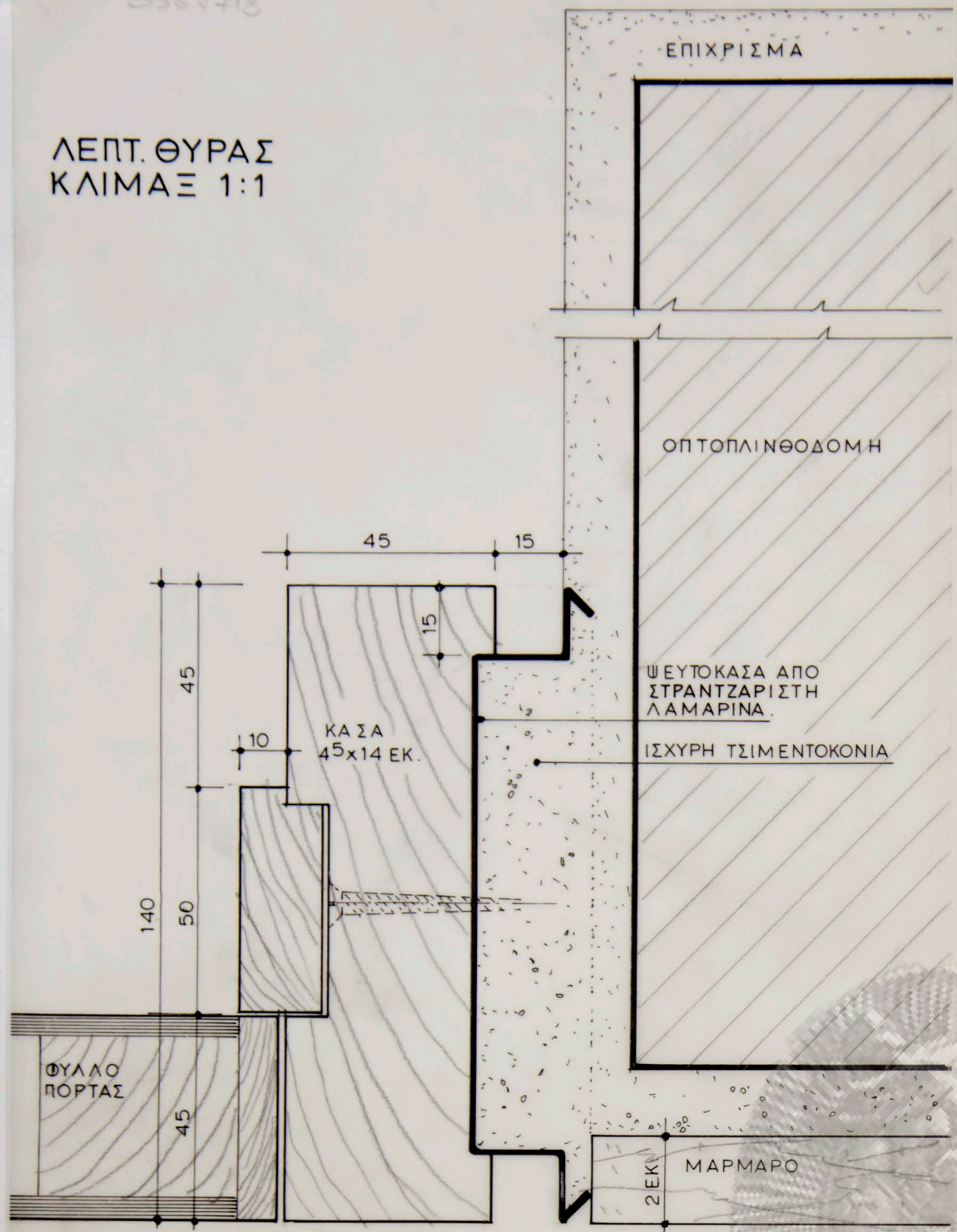

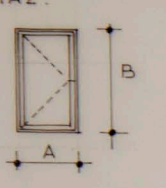
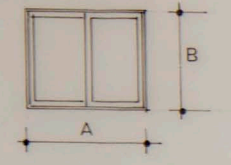
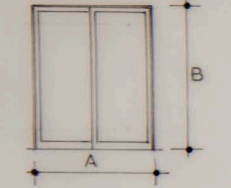
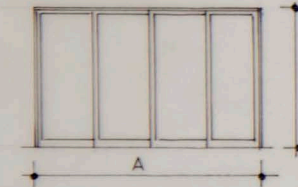
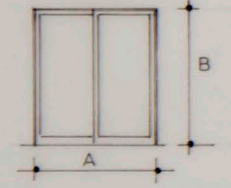
ΠΕΡΙΓΡΑΦΗ	ΔΙΑΣΤΑΣΕΙΣ		ΘΕΣΗ	ΠΟΣΟΤΗΣ	ΠΑΡΑΤΗΡΗΣΕΙΣ
	A	B			
ΠΑΡΑΘΥΡΟ ΜΟΝΟΦΥΛΛΟ ΑΝΟΙΓΜΕΝΟ ΜΕ ΣΙΔΕΡΙΑ ΑΣΦΑΛΕΙΑΣ. 	0.55	1.50	ΥΠΟΓΕΙΟ	1	Υ1 ΠΟΔ. 1.15 ΠΡ. 2.65
ΠΑΡΑΘΥΡΟ ΔΙΦΥΛΛΟ ΕΠΑΛΛΗΛΟ ΜΕ ΡΟΛΟ. 	1.55	1.70	ΥΠΟΓΕΙΟ	2	Υ2, Υ3 ΠΟΔ. 0.95 ΠΡ. 2.65 Υ5 ΠΟΔ. 0.95-ΠΡ. 2.65 Υ5 ΠΟΔ. 1.15-ΠΡ. 2.85
	215	1.70	»	1	
	155	1.70	ΙΣΟΓΕΙΟ	1	
ΠΟΡΤΑ ΔΙΦΥΛΛΗ ΕΠΑΛΛΗΛΗ ΜΕ ΡΟΛΟ. 	2.15	2.65	ΥΠΟΓΕΙΟ	1	Υ6
ΠΟΡΤΑ ΤΕΤΡΑΦΥΛΛΗ ΕΠΑΛΛΗΛΗ ΜΕ ΠΑΝΤΖΟΥΡΙΑ (ΑΛΛΗΛΟΣΥΡΟΜ.). 	11.30	2.85	ΙΣΟΓΕΙΟ	1	Υ1
ΠΟΡΤΑ ΔΙΦΥΛΛΗ ΕΠΑΛΛΗΛΗ ΜΕ ΠΑΝΤΟΥΡΙΑ (ΑΛΛΗΛΟΣΥΡΟΜΕΝΗ). 	5.30	2.85	ΙΣΟΓΕΙΟ	1	Υ2

ΥΨΗ ΑΠΟ ΠΛΑΚΑ ΜΠΕΤΟΝ

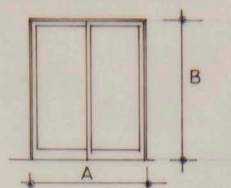
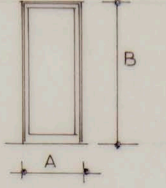
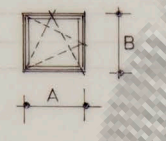
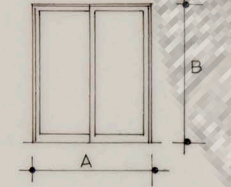
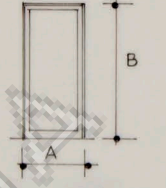
ΠΕΡΙΓΡΑΦΗ	ΔΙΑΣΤΑΣΕΙΣ		ΘΕΣΗ	ΠΟΣΟΤΗΣ	ΠΑΡΑΤΗΡΗΣΕΙΣ
	A	B			
ΠΟΡΤΑ ΔΙΦΥΛΛΗ ΕΠΑΛΛΗΛΗ ΜΕ ΠΑΝΤΖΟΥΡΙΑ 	3.80	2.85	ΙΣΟΓΕΙΟ	1	Υ3 ΔΣ ΚΑΤΟΦΗ
ΠΟΡΤΑ ΜΟΝΟΦΥΛΛΗ ΜΕ ΠΑΝΤΖΟΥΡΙΑ ΣΥΡΟΜΕΝΗ. 	2.40	2.85	ΙΣΟΓΕΙΟ	1	Υ4
ΠΑΡΑΘΥΡΟ ΜΟΝΟΦΥΛΛΟ ΔΙΑΞΟΝΙΚΟ ΜΕ ΣΙΔΕΡΙΑ ΑΣΦΑΛΕΙΑΣ. 	0.80	0.80	ΙΣΟΓΕΙΟ	1	Υ6 ΠΟΔ. 1.65 ΠΡ. 2.45
ΔΙΦΥΛΛΗ ΣΥΡΟΜΕΝΗ ΠΟΡΤΑ ΜΕ ΣΙΤΑ ΚΑΙ ΠΑΝΤΖΟΥΡΙΑ. 	3.69	2.75	Α' ΟΡΟΦΟΣ	1	Υ1
ΠΟΡΤΑ ΜΟΝΟΦΥΛΛΗ ΣΥΡΟΜΕΝΗ ΜΕ ΣΙΤΑ ΚΑΙ ΠΑΝΤΖΟΥΡΙΑ. 	1.84	2.75	Α' ΟΡΟΦΟΣ	2	Υ2, Υ3

ΥΨΗ ΑΠΟ ΠΛΑΚΑ ΜΠΕΤΟΝ

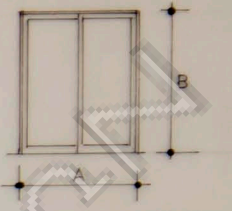
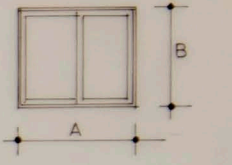
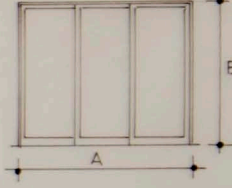
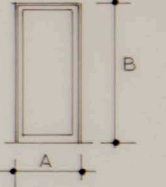
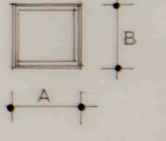
ΠΕΡΙΓΡΑΦΗ	ΔΙΑΣΤΑΣΕΙΣ		ΘΕΣΗ	ΠΟΣΟΤΗΣ	ΠΑΡΑΤΗΡΗΣΕΙΣ
	A	B			
ΠΟΡΤΑ ΔΙΦΥΛΛΗ ΜΕ ΡΟΛΟ ΚΑΙ (ΑΛΛΗΛΟΣΥΡΟΜΕΝΗ) ΣΙΤΑ 	2.85	2.75	Α' ΟΡΟΦΟΣ	1	Υ4, Υ5
ΠΑΡΑΘΥΡΟ ΔΙΦΥΛΛΟ ΕΠΑΛΛΗΛΟ ΜΕ ΡΟΛΟ & ΣΙΤΑ 	1.55	1.70	Α' ΟΡΟΦΟΣ	1	Υ6 ΠΟΔ. 1.05 Υ7, Υ8 » 1.65
	1.85	1.10	»	2	
ΠΟΡΤΑ ΤΡΙΦΥΛΛΗ ΕΠΑΛΛΗΛΗ ΜΕ ΠΑΝΤΖΟΥΡΙΑ (ΑΛΛΗΛΟΣΥΡΟΜΕΝΗ). 	5.53	2.70	Β' ΟΡΟΦΟΣ	1	Υ1
ΠΟΡΤΑ ΜΟΝΟΦΥΛΛΗ ΣΥΡΟΜΕΝΗ ΜΕ ΣΙΤΑ ΚΑΙ ΠΑΝΤΖΟΥΡΙΑ & ΣΙΤΑ 	100	2.70	Β' ΟΡΟΦΟΣ	1	Υ2, Υ3 Υ4
115	2.70	»	2		
ΠΑΡΑΘΥΡΟ ΣΥΡΟΜΕΝΟ ΜΕ ΣΙΤΑ ΚΑΙ ΠΑΝΤΖΟΥΡΙΑ. 	0.80	0.80	Β' ΟΡΟΦΟΣ	1	Υ5 ΠΟΔ. 1.65 ΠΡ. 2.45

ΥΨΗ: ΑΠΟ ΠΛΑΚΑ ΜΠΕΤΟΝ

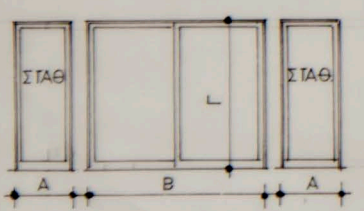
ΠΕΡΙΓΡΑΦΗ	ΔΙΑΣΤΑΣΕΙΣ	ΘΕΣΗ	ΠΟΣΟΤΗΣ	ΠΑΡΑΤΗΡΗΣΕΙΣ
ΠΟΡΤΑ ΔΙΦΥΛΛΗ ΕΠΑΛΛΗΛΗ 	A 1.00 B 3.15 Γ 2.65	ΥΠΟΓΕΙΟ	1	Υ4

ΟΙΚΙΑ ΣΤΕΦ. ΖΑΧΑΡΙΑΔΗ
ΕΠΙ ΤΩΝ ΟΔΩΝ ΕΥΡΥΔΙΚΗΣ
ΚΑΙ ΤΕΡΨΙΧΟΡΗΣ-ΒΟΥΛΙΑΓΜΕΝΗ
 ΠΙΝΑΚΑΣ ΚΟΥΦΩΜΑΤΩΝ (ΥΑΛΟΣΤΑΣΙΑ).

ΑΡΧΙΤΕΚΤΩΝ: Ν. ΒΑΛΣΑΜΑΚΗΣ

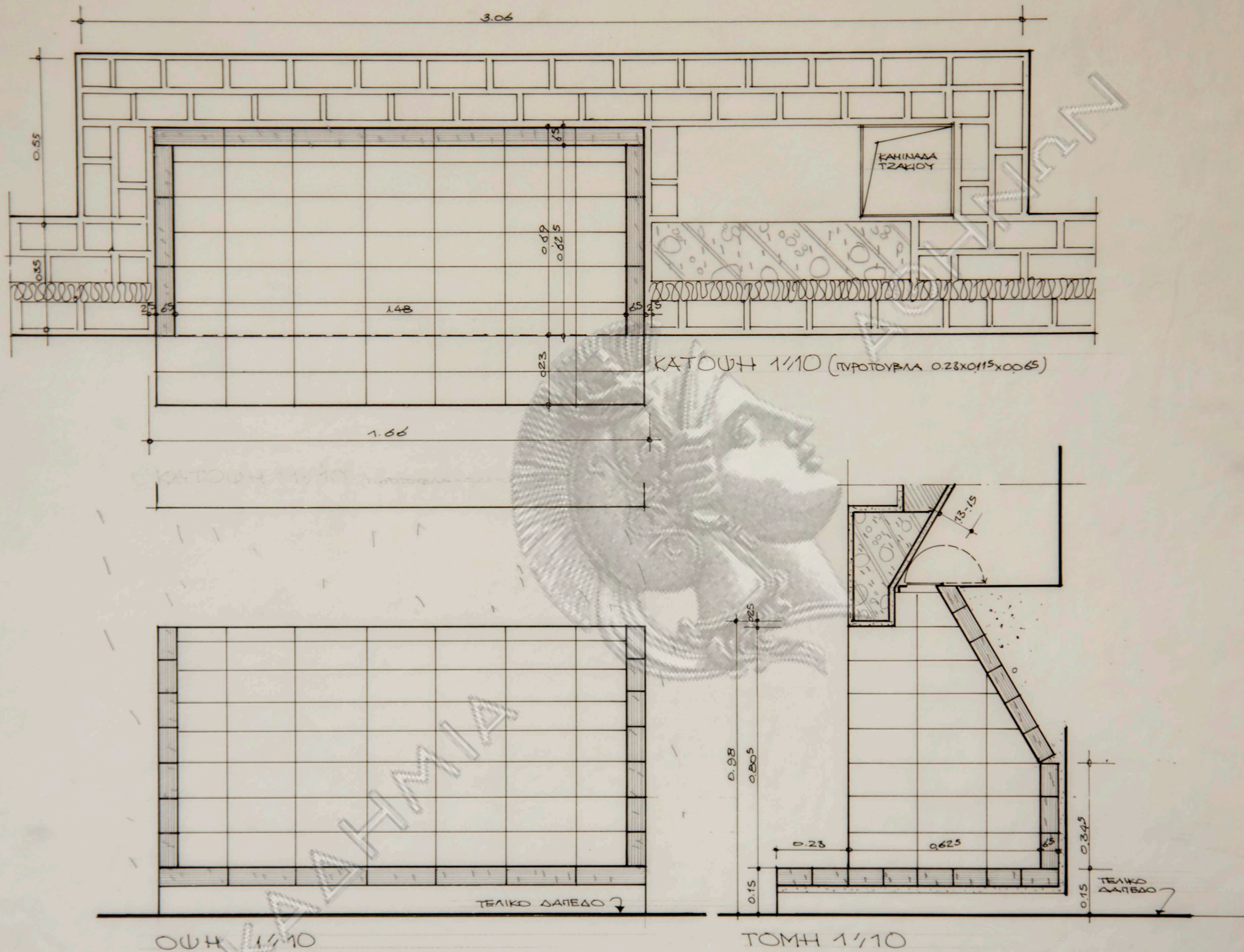

ΟΙΚΙΑ ΣΤΕΦ. ΖΑΧΑΡΙΑΔΗ
ΕΠΙ ΤΩΝ ΟΔΩΝ ΕΥΡΥΔΙΚΗΣ
ΚΑΙ ΤΕΡΨΙΧΟΡΗΣ-ΒΟΥΛΙΑΓΜΕΝΗ

ΑΡΧΙΤΕΚΤΩΝ: Ν. ΒΑΛΣΑΜΑΚΗΣ

Θ5.

ΟΨΗ ΚΛ. 1:20

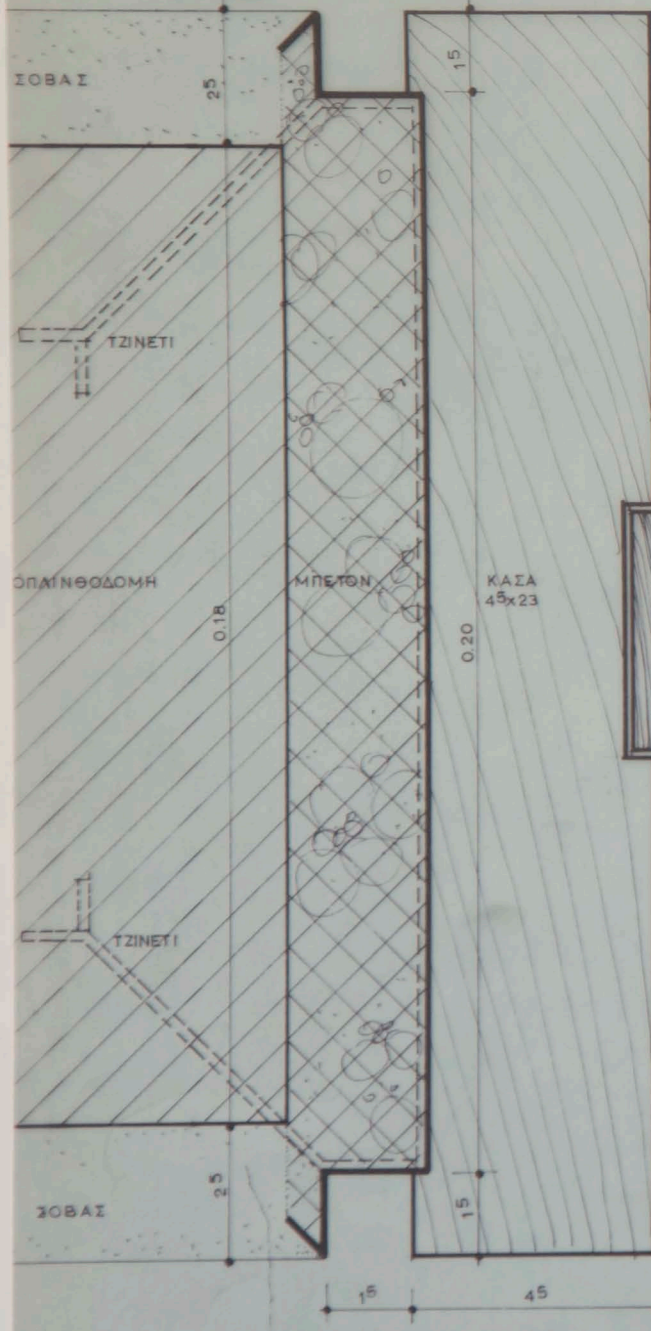
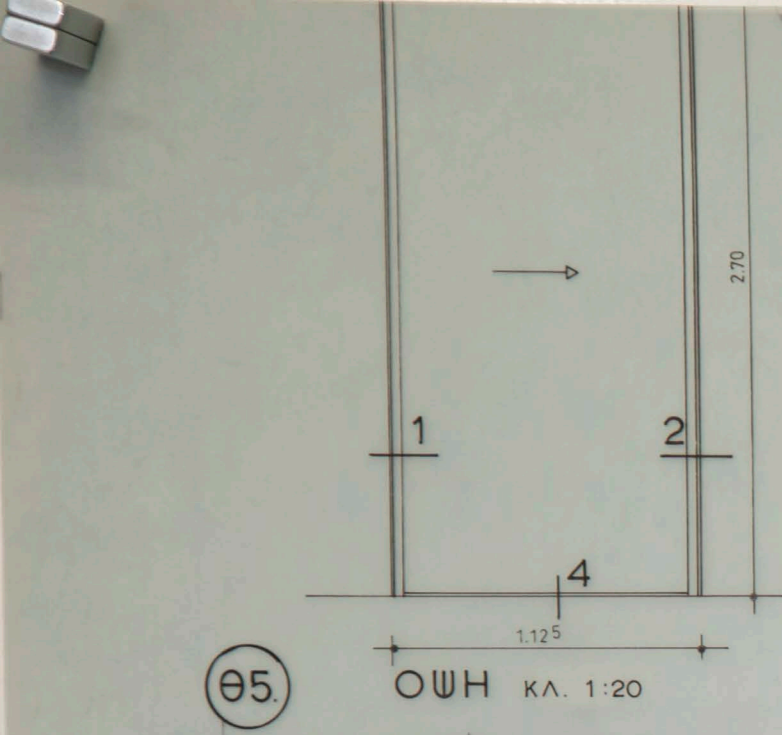

1

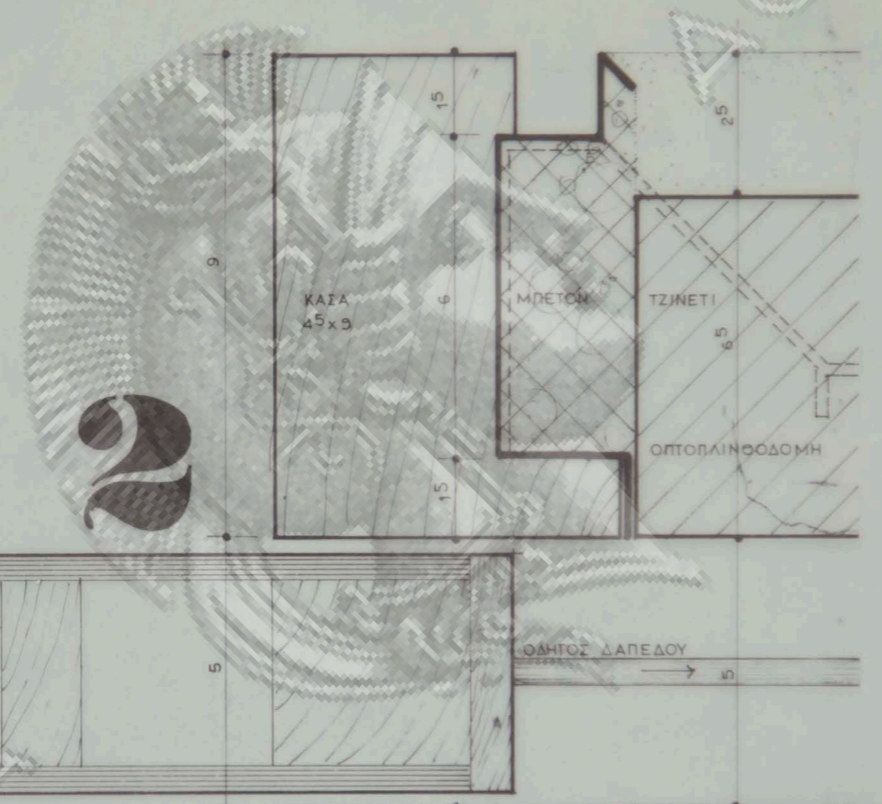

2

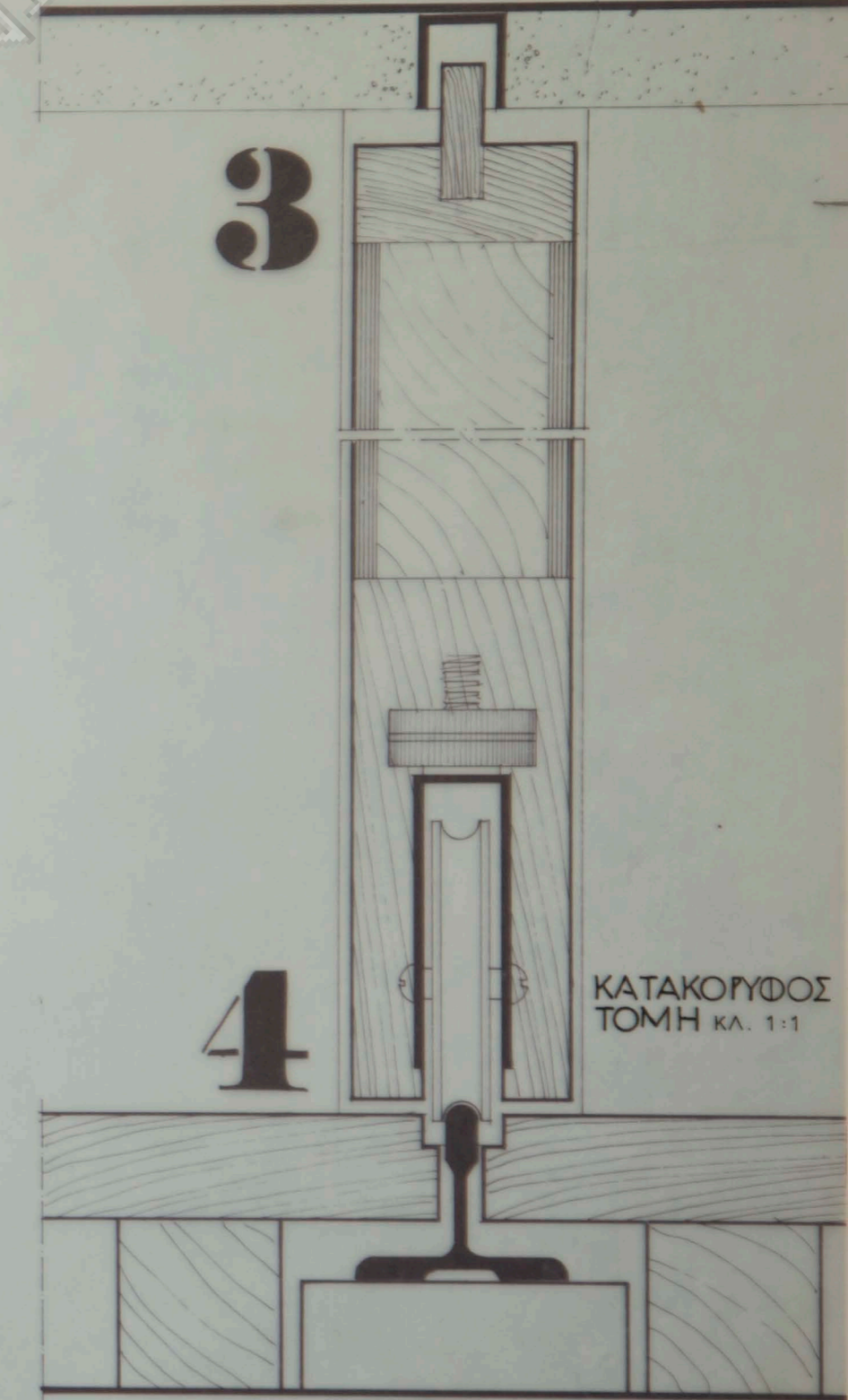
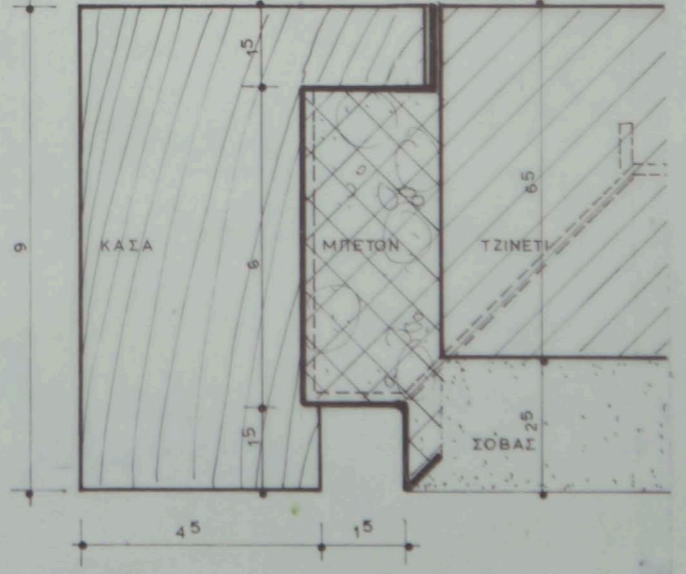

ΡΙΖΟΝΤΙΟΣ ΤΟΜΗ ΚΛ. 1:1

ΟΙΚΙΑ ΣΤΕΦ. ΖΑΧΑΡΙΑΔΗ
ΕΠΙ ΤΩΝ ΟΔΩΝ ΕΥΡΥΔΙΚΗΣ
ΚΑΙ ΤΕΡΨΙΧΟΡΗΣ-ΒΟΥΛΙΑΓΜΕΝΗ
ΘΥΡΑ ΣΥΡΤΗ ΠΡΕΣΣΑΡΙΣΤΗ ΚΛ. 1:1 1:20

ΑΡΧΙΤΕΚΤΩΝ: Ν. ΒΑΣΣΑΜΑΚΗΣ

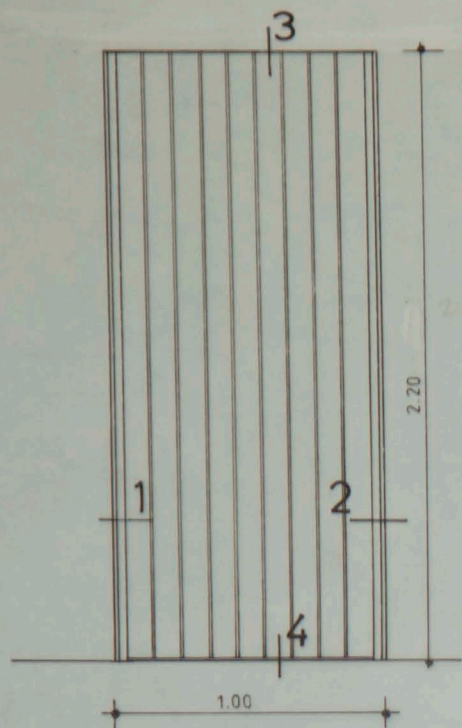

οψη 1:20

Θ1.

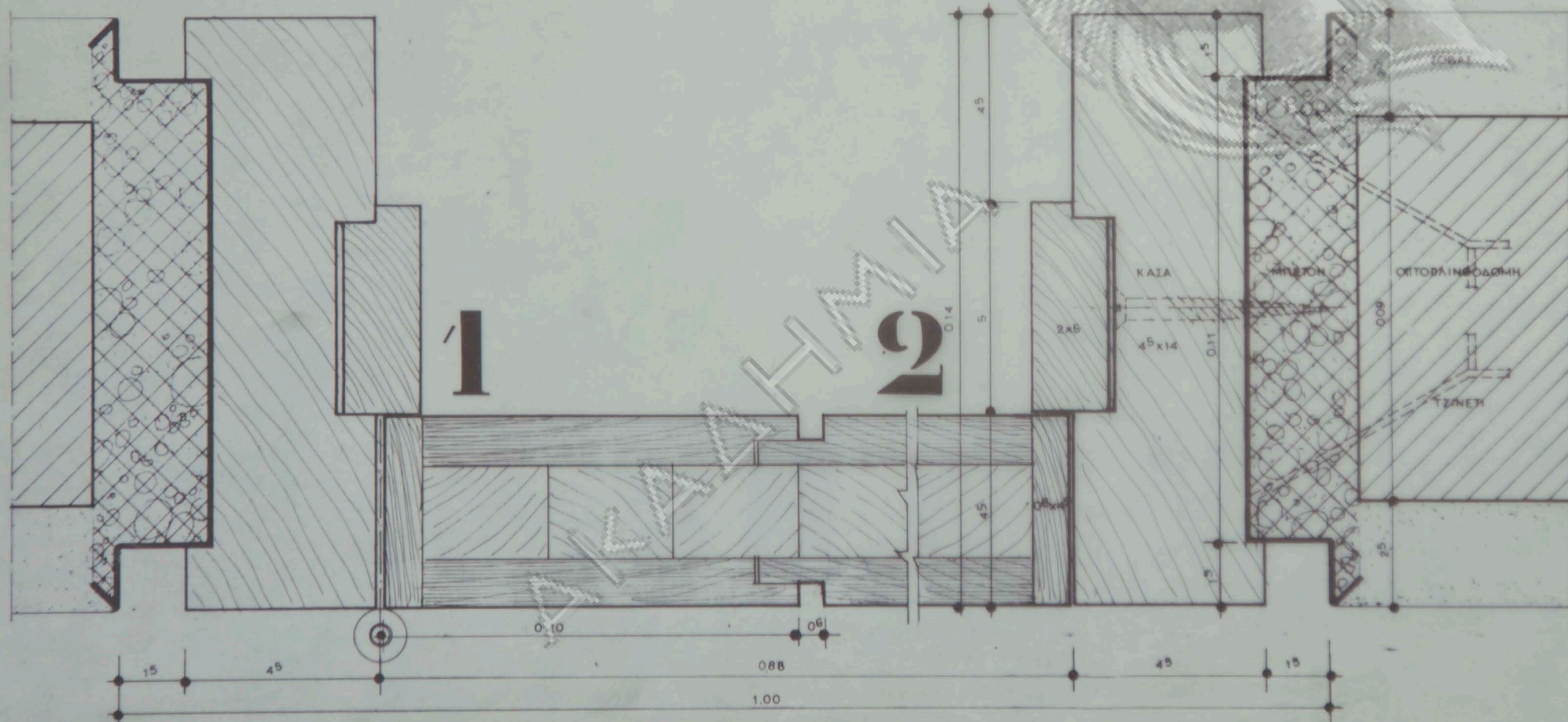

οριζοντιος τομη κλ. 1:1

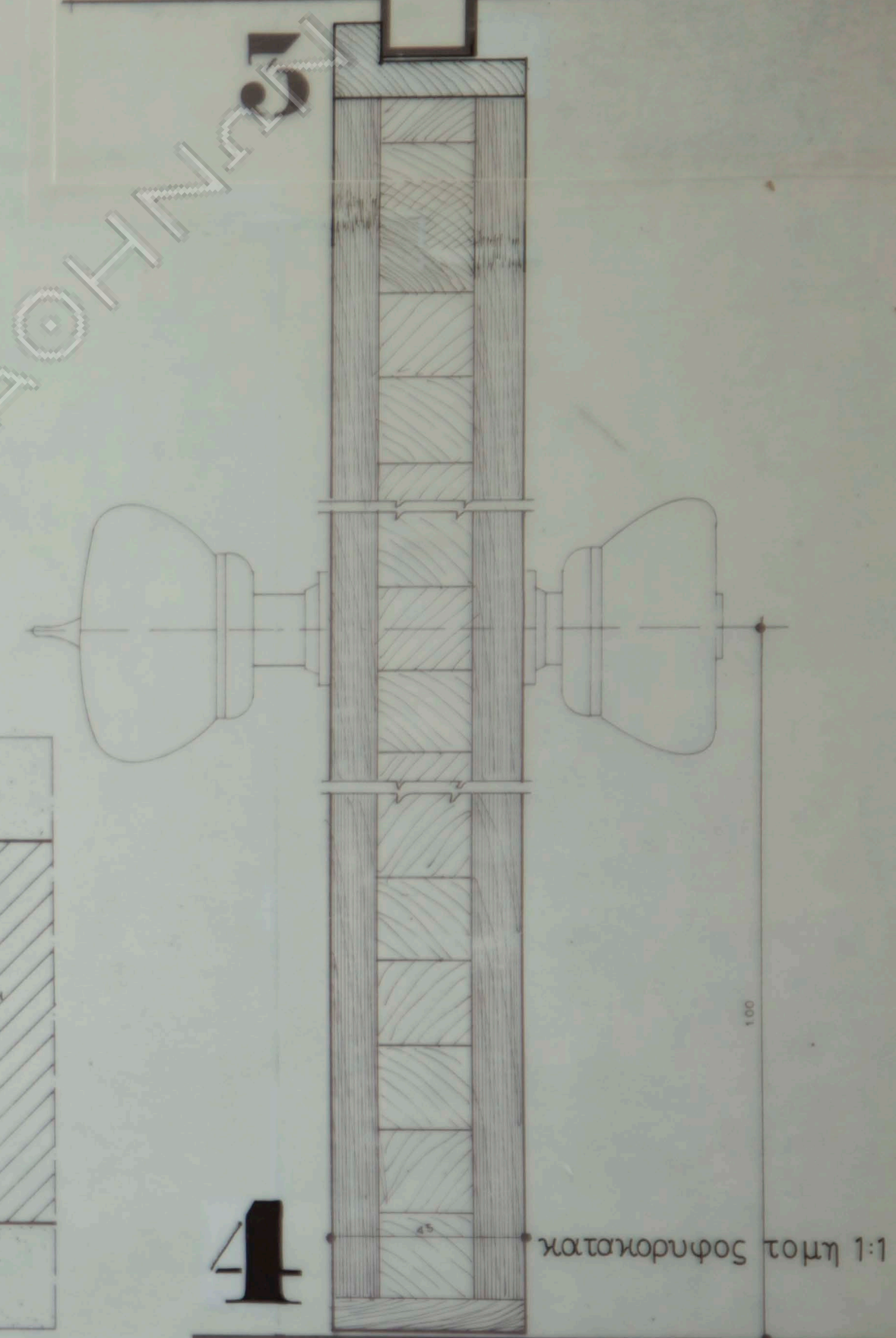

ΟΙΚΙΑ ΣΤΕΦ. ΖΑΧΑΡΙΑΔΗ
 ΕΠΙ ΤΩΝ ΟΔΩΝ ΕΥΡΥΔΙΚΗΣ
 ΚΑΙ ΤΕΡΨΙΧΟΡΗΣ-ΒΟΥΛΙΑΓΜΕΝΗ
 ΘΥΡΑ ΡΑΜΠΟΤΕ ΚΛ. 1:1 1:20

ΑΡΧΙΤΕΚΤΩΝ: Ν. ΒΑΛΣΑΜΑΚΗΣ



ΩΙΣ ΕΞΩΤΕΡΙΚΗ
ΚΛΙΜΑΣ 1:10

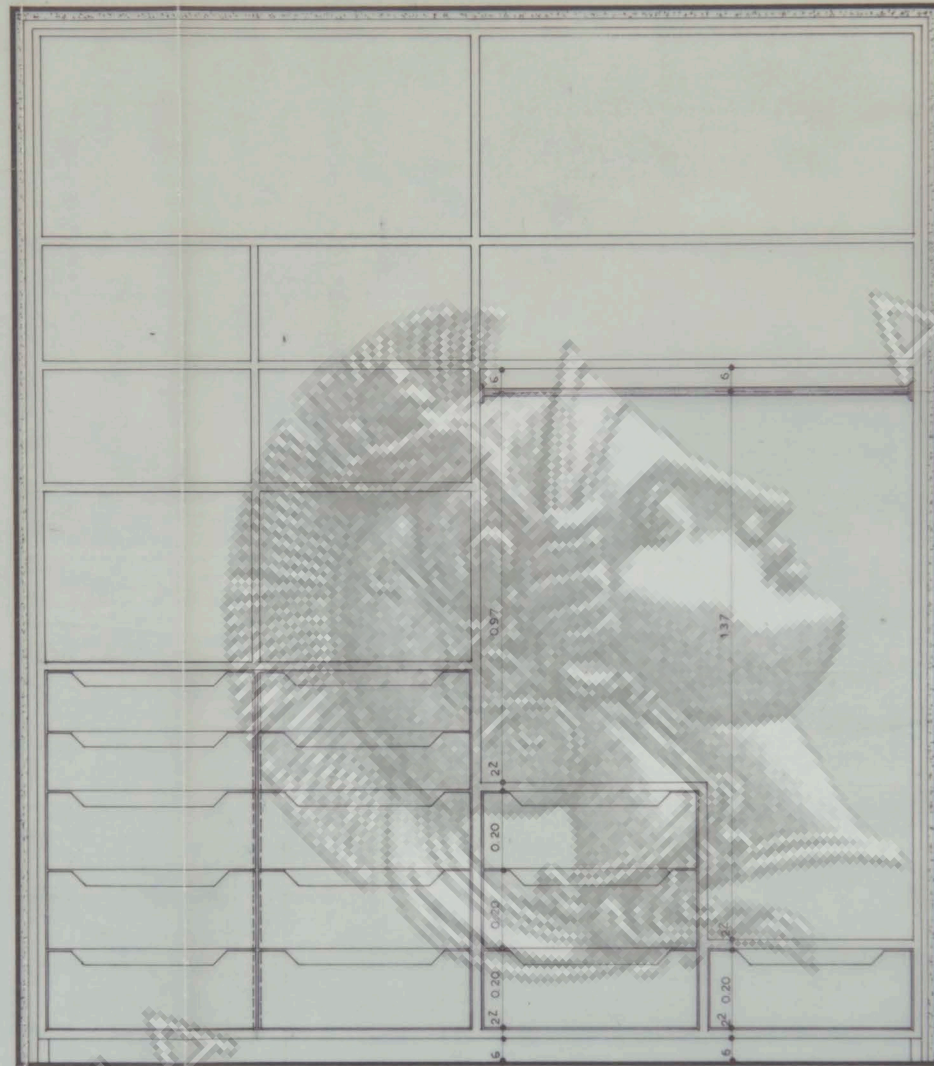

ΩΙΣ ΕΣΩΤΕΡΙΚΗ
ΚΛΙΜΑΣ 1:10



ΤΟΜΗ
ΚΛΙΜΑΣ 1:10

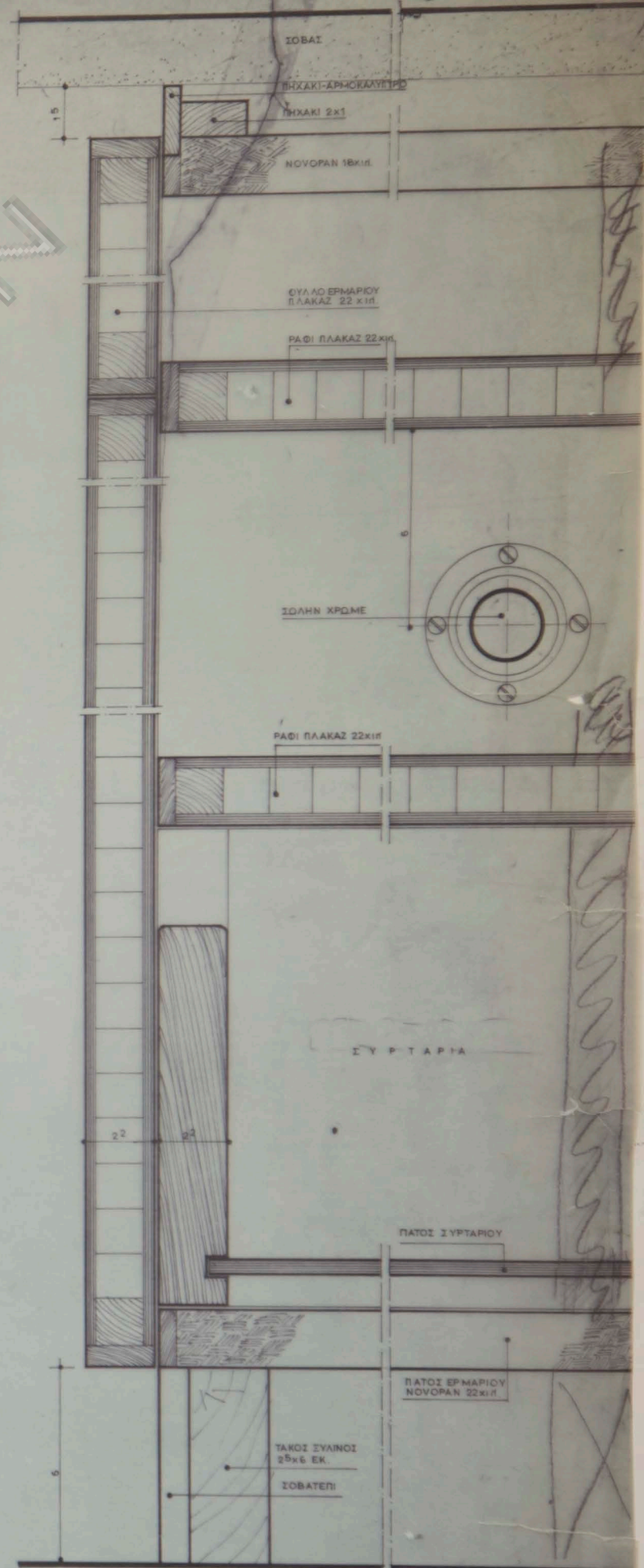

ΚΑΤΑΚΟΡΥΦΟΣ ΤΟΜΗ
ΚΛΙΜΑΣ 1:1

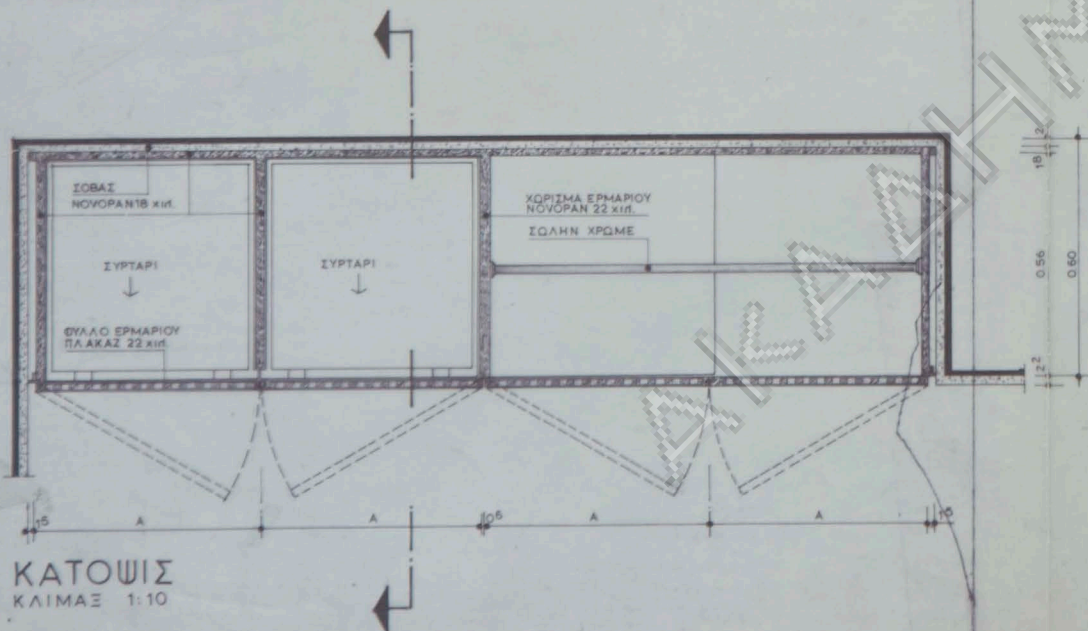

ΚΑΤΩΨΙΣ
ΚΛΙΜΑΣ 1:10

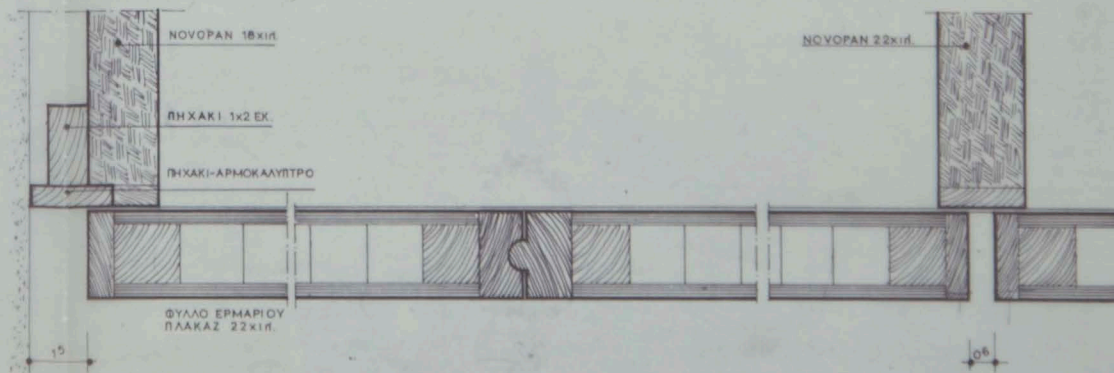

ΟΡΙΖΟΝΤΙΟΣ ΤΟΜΗ
ΚΛΙΜΑΣ 1:1

ΣΗΜΕΙΩΣΗ: ΟΙ ΔΙΑΣΤΑΣΕΙΣ ΕΙΝΑΙ ΕΝΔΕΙΚΤΙΚΕΣ, ΠΡΑΓΜΑΤΩΣ ΝΑ ΠΑΡΟΥΝΤΑΙ ΕΠΙ ΤΟΠΟΥ.

ΟΙΚΙΑ ΣΤΕΦ. ΖΑΧΑΡΙΑΔΗ
ΕΠΙ ΤΩΝ ΟΔΩΝ ΕΥΡΥΔΙΚΗΣ
ΚΑΙ ΤΕΡΨΙΧΟΡΗΣ-ΒΟΥΛΙΑΓΜΕΝΗ
ΛΕΠΤ. ΕΡΜΑΡΙΩΝ
ΑΡΧΙΤΕΚΤΩΝ: Ν. ΒΑΣΣΑΜΑΚΗΣ

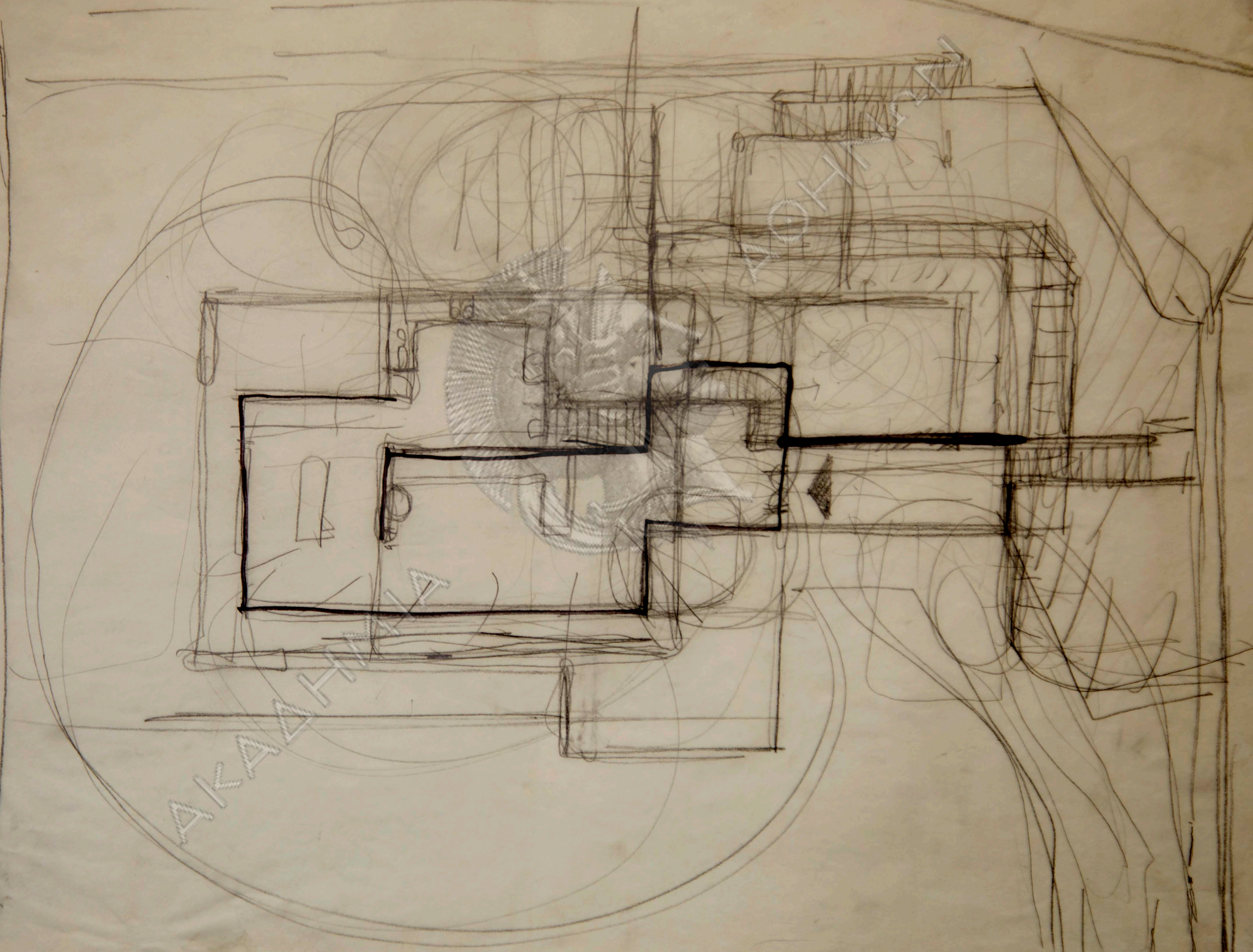

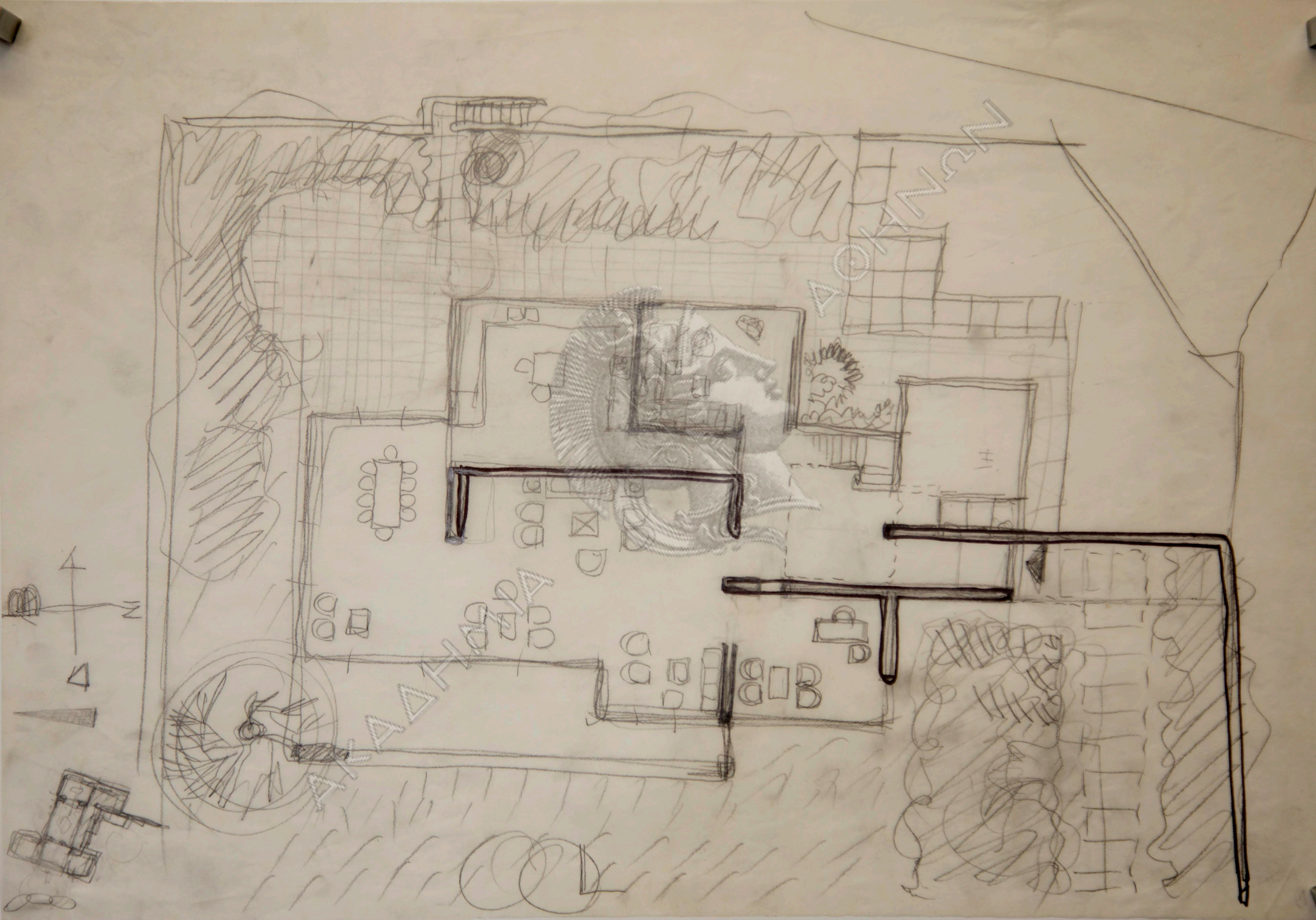

214
242

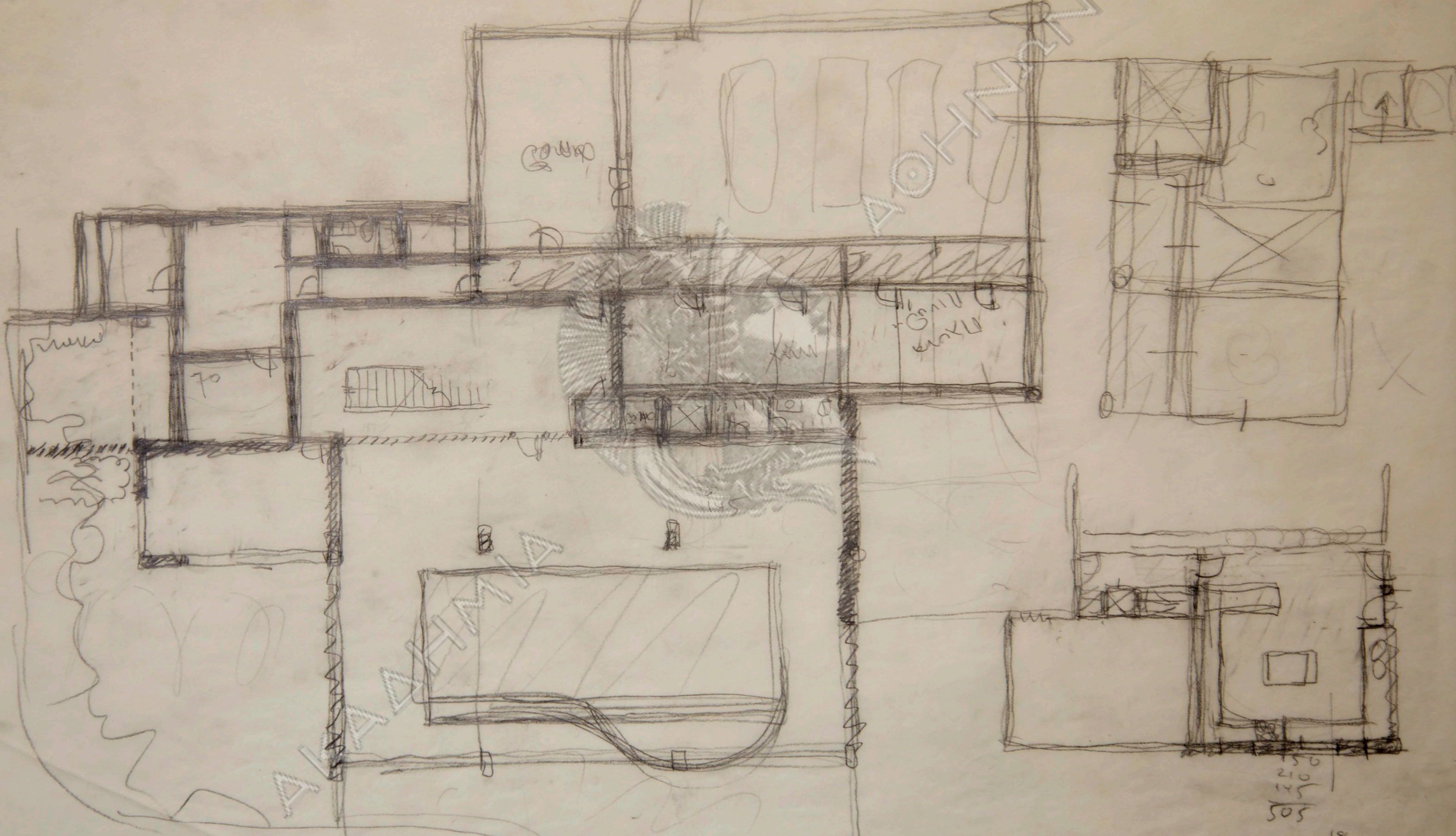

Handwritten label, possibly 'Handed' or similar.

Handwritten label, possibly 'Handed' or similar.

70

Handwritten label, possibly 'Handed' or similar.

28

Handwritten calculations:

156	18	12
210	12	12
145	36	24
505	18	12
	360	104
	216	
45		
900		

30
39
Floral sketch

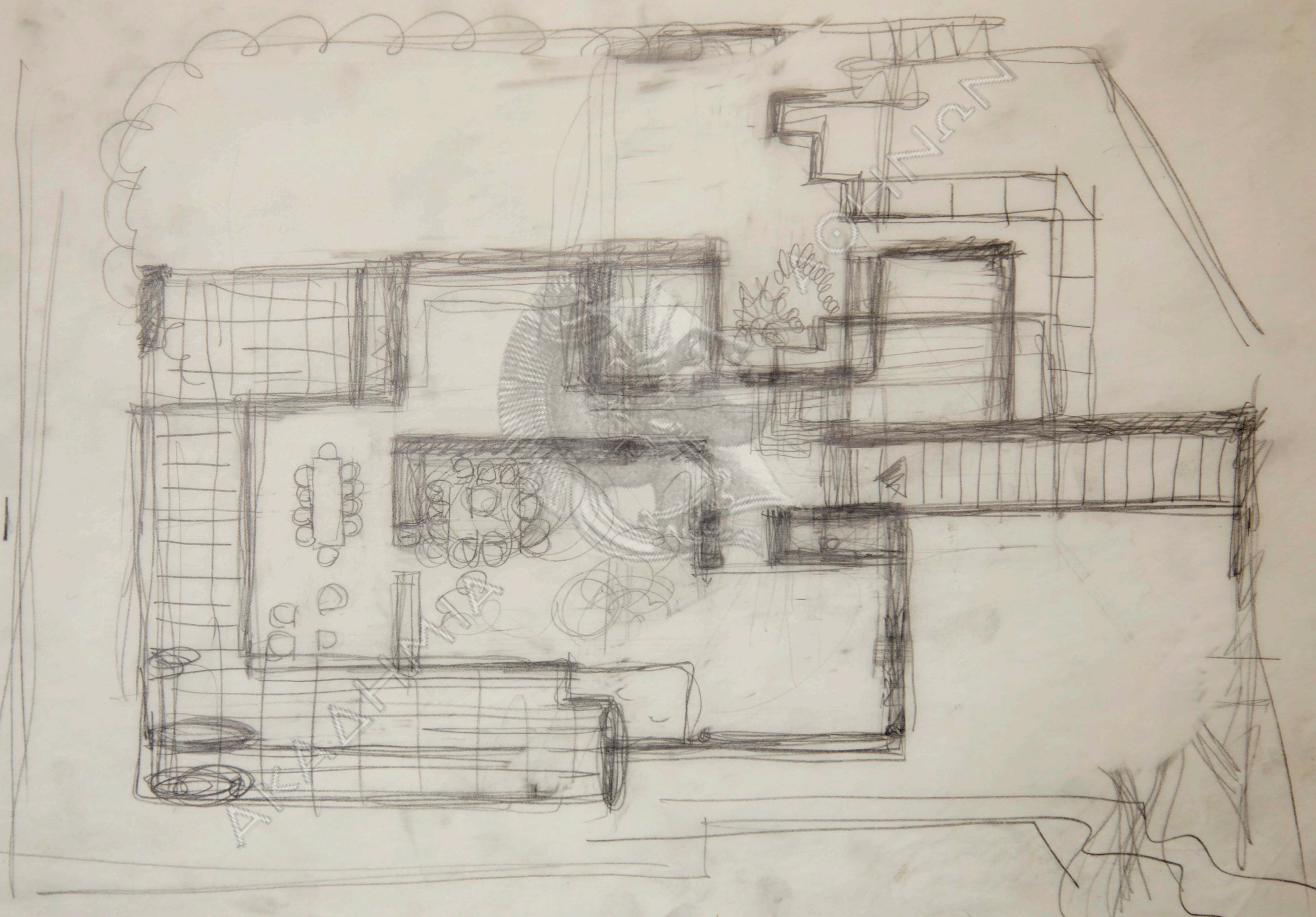

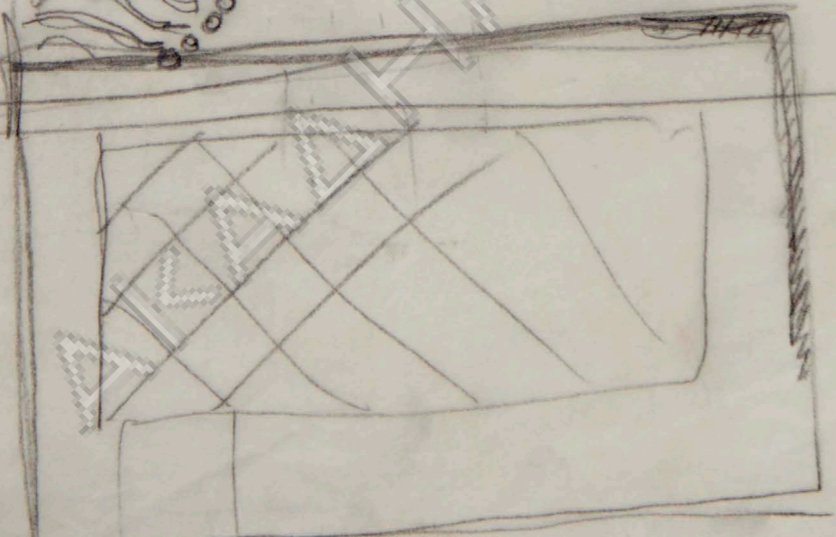
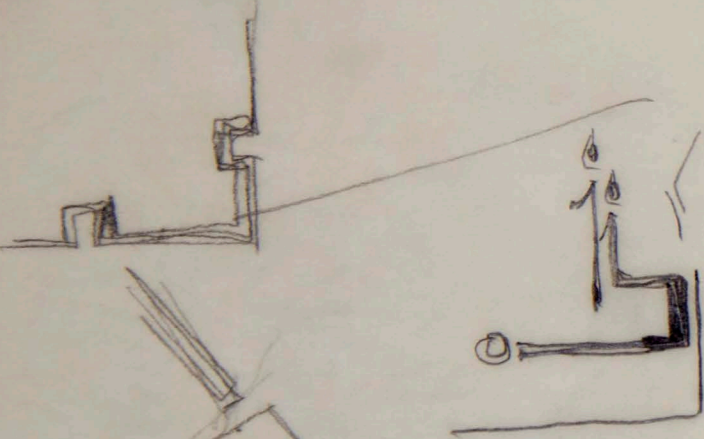
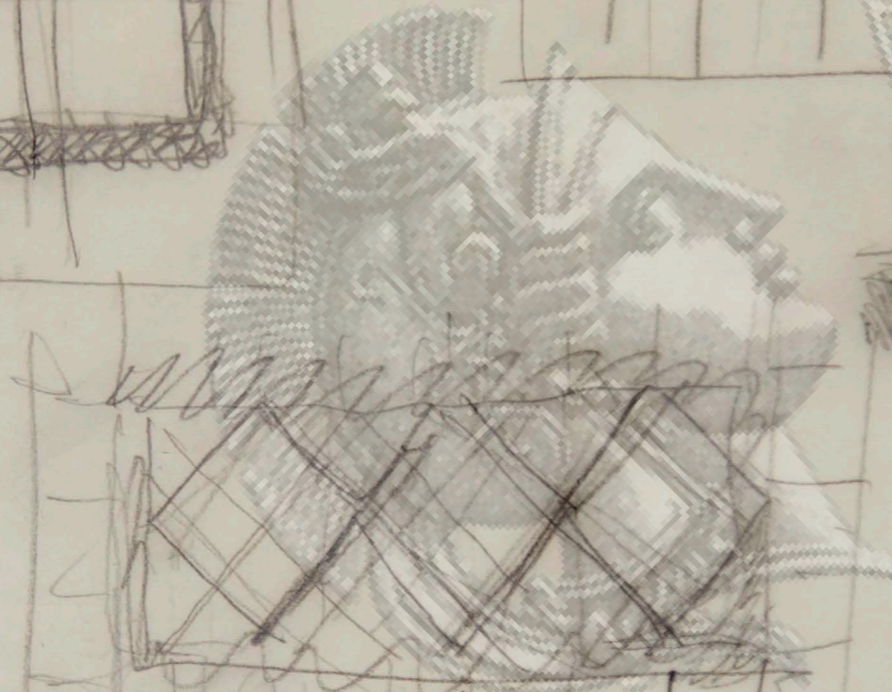
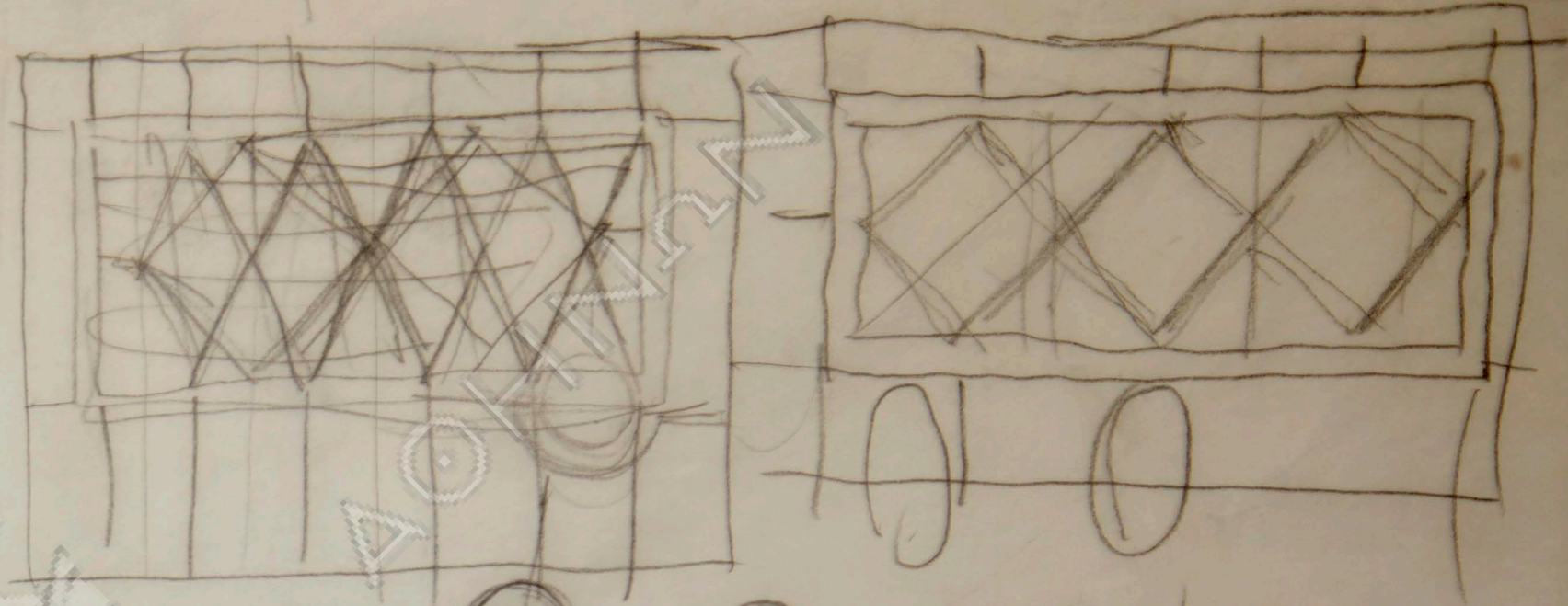
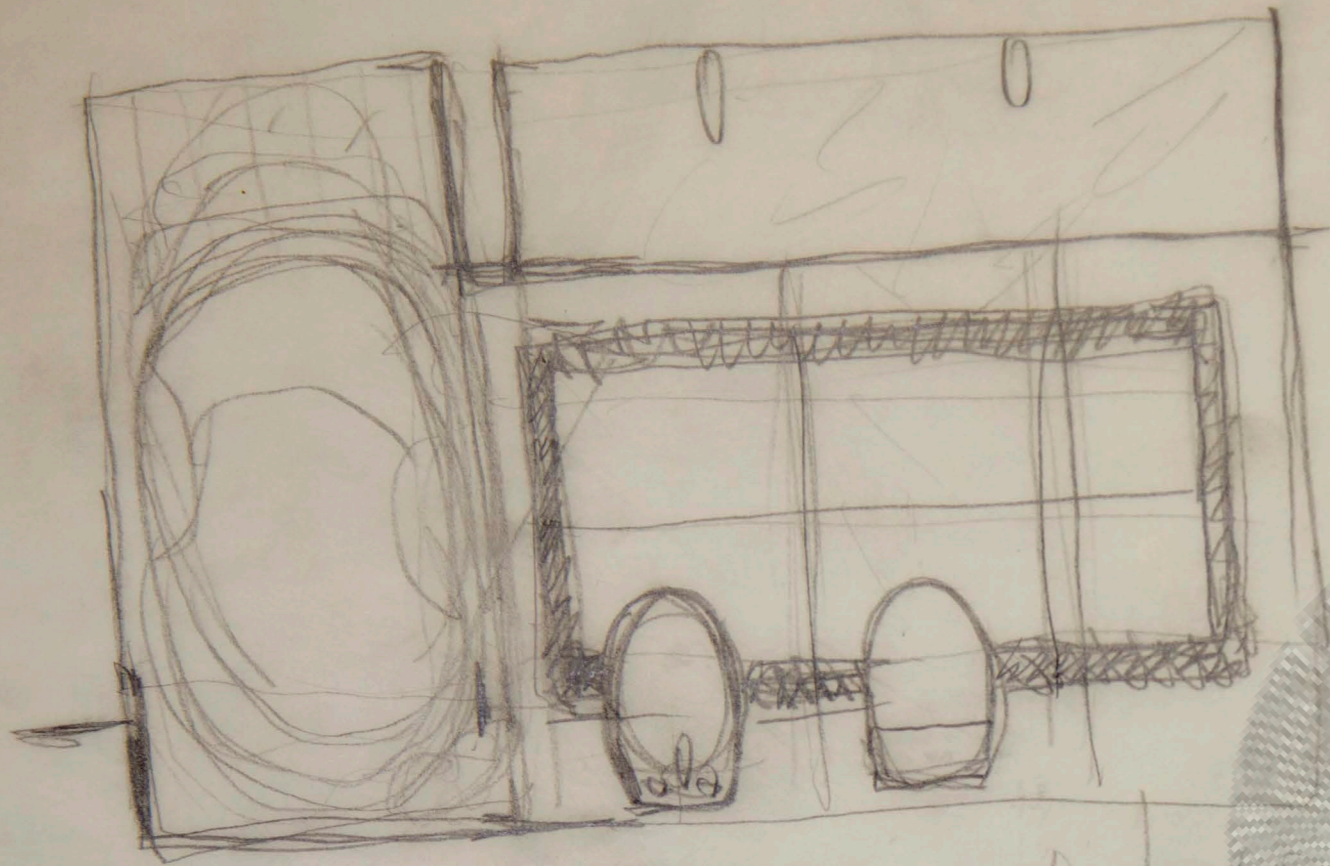

Ardo

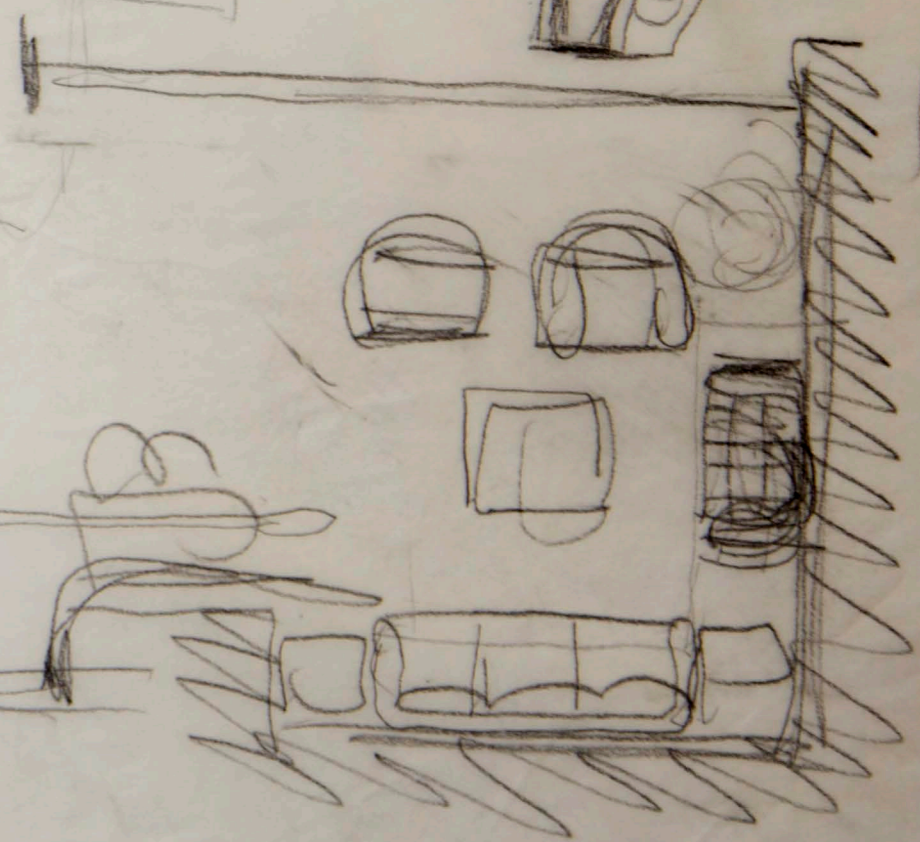
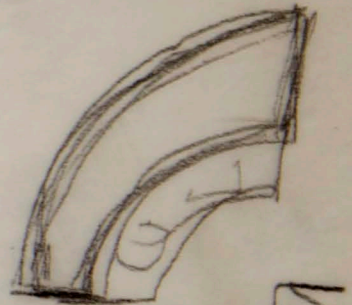
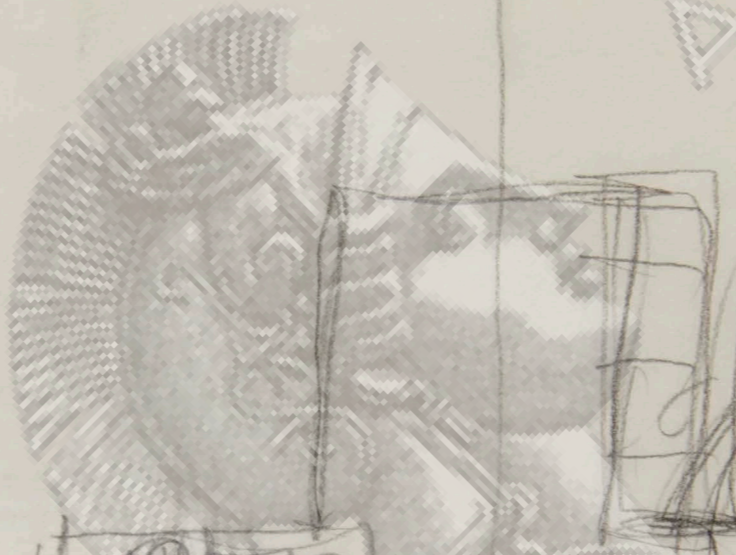
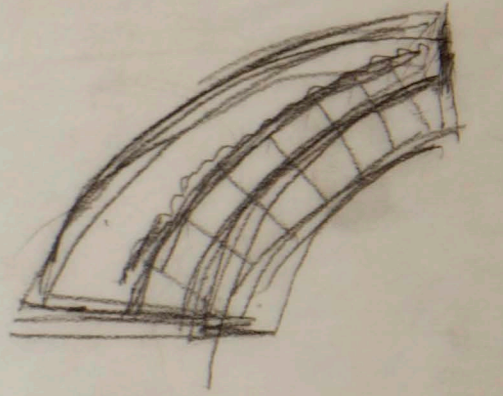
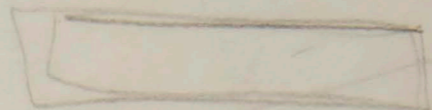
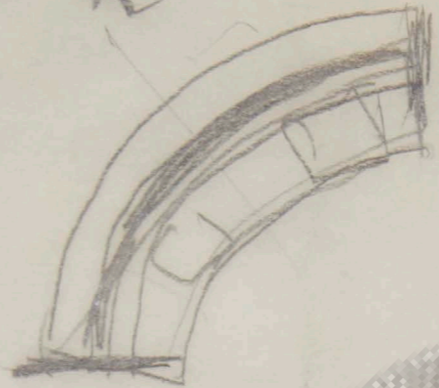
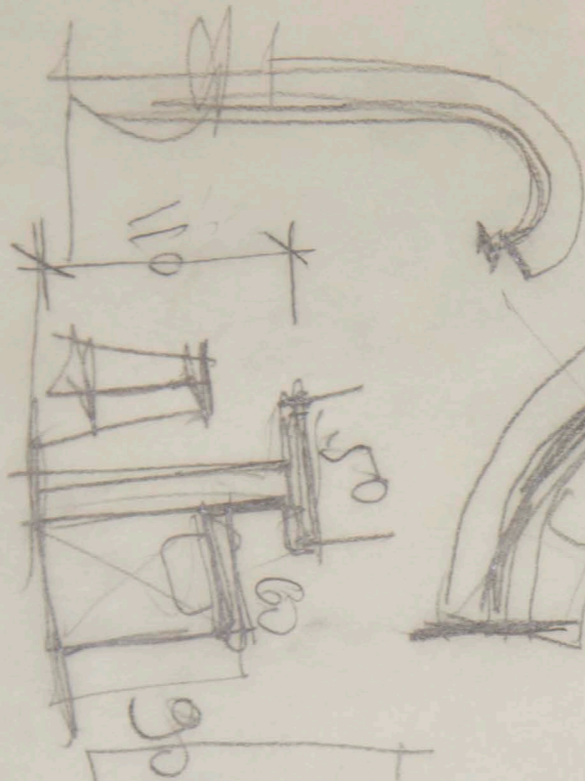

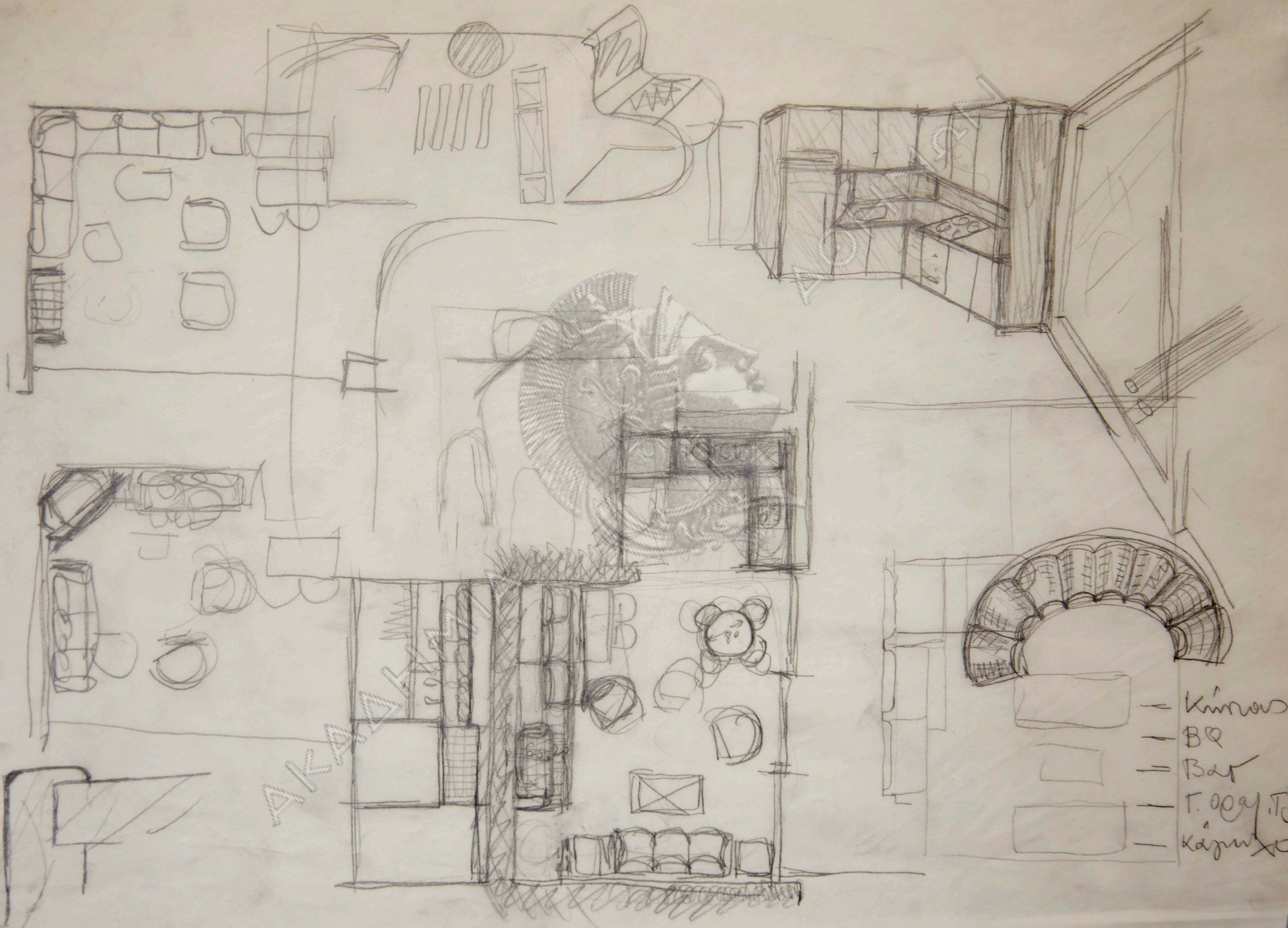

AKA

- Kuvvet
- BQ
- Bar
- T. 009. T. Jan
- Kapan 20

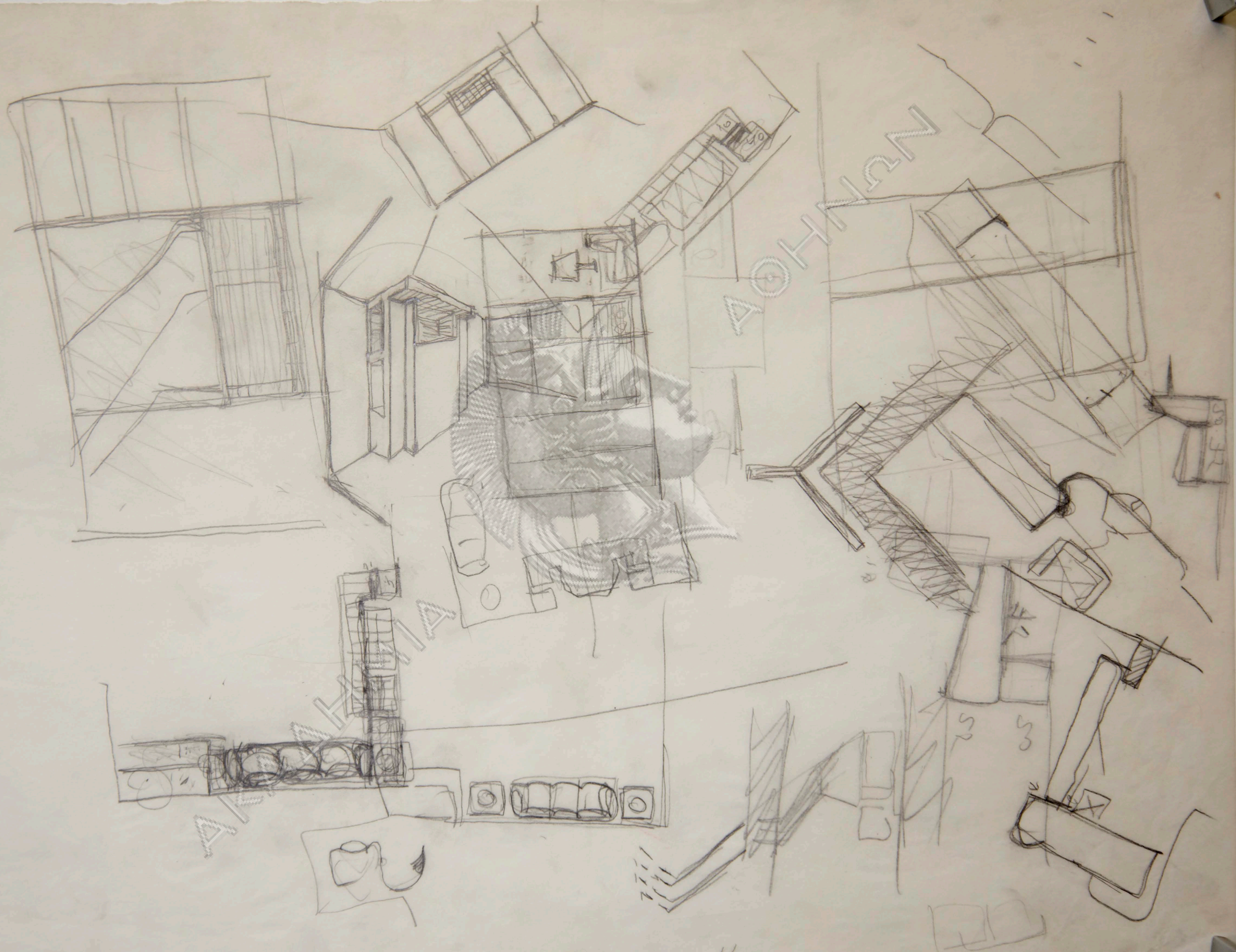

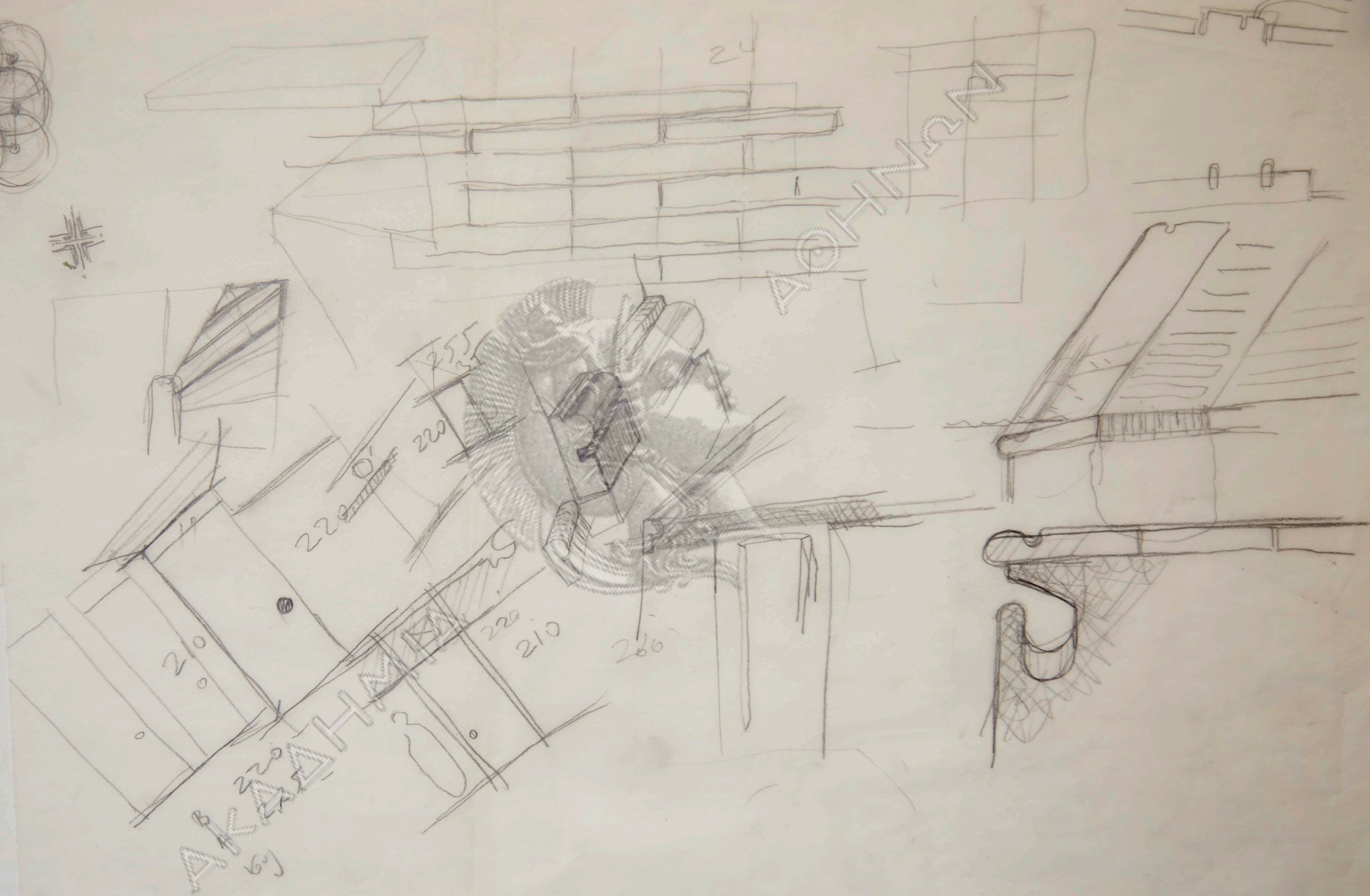
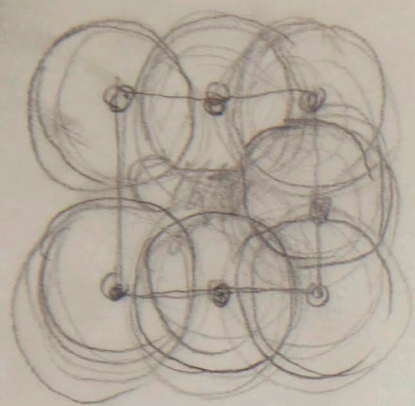

+94.85

+106.60

+100.80

+98.50

+98.50

+102.20

8.00x12.00

+101.50

3.90x1.60

+101.50

2.10x1.60

5.00x10.00

6.00x6.00

+96.53

+109.09

81/4

ΙΣΟΓΕΙΟ

E= 189.00 M2

