

2

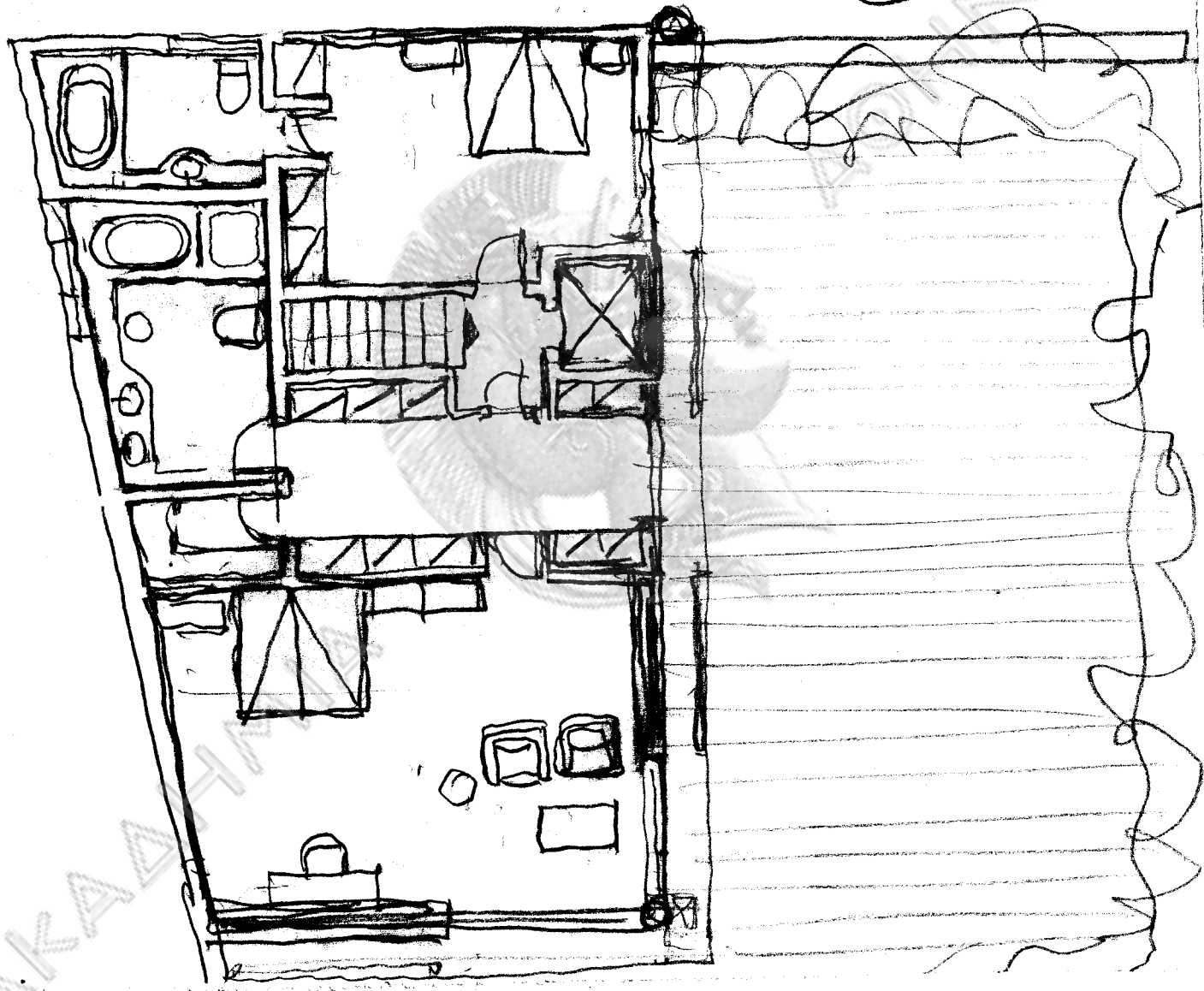

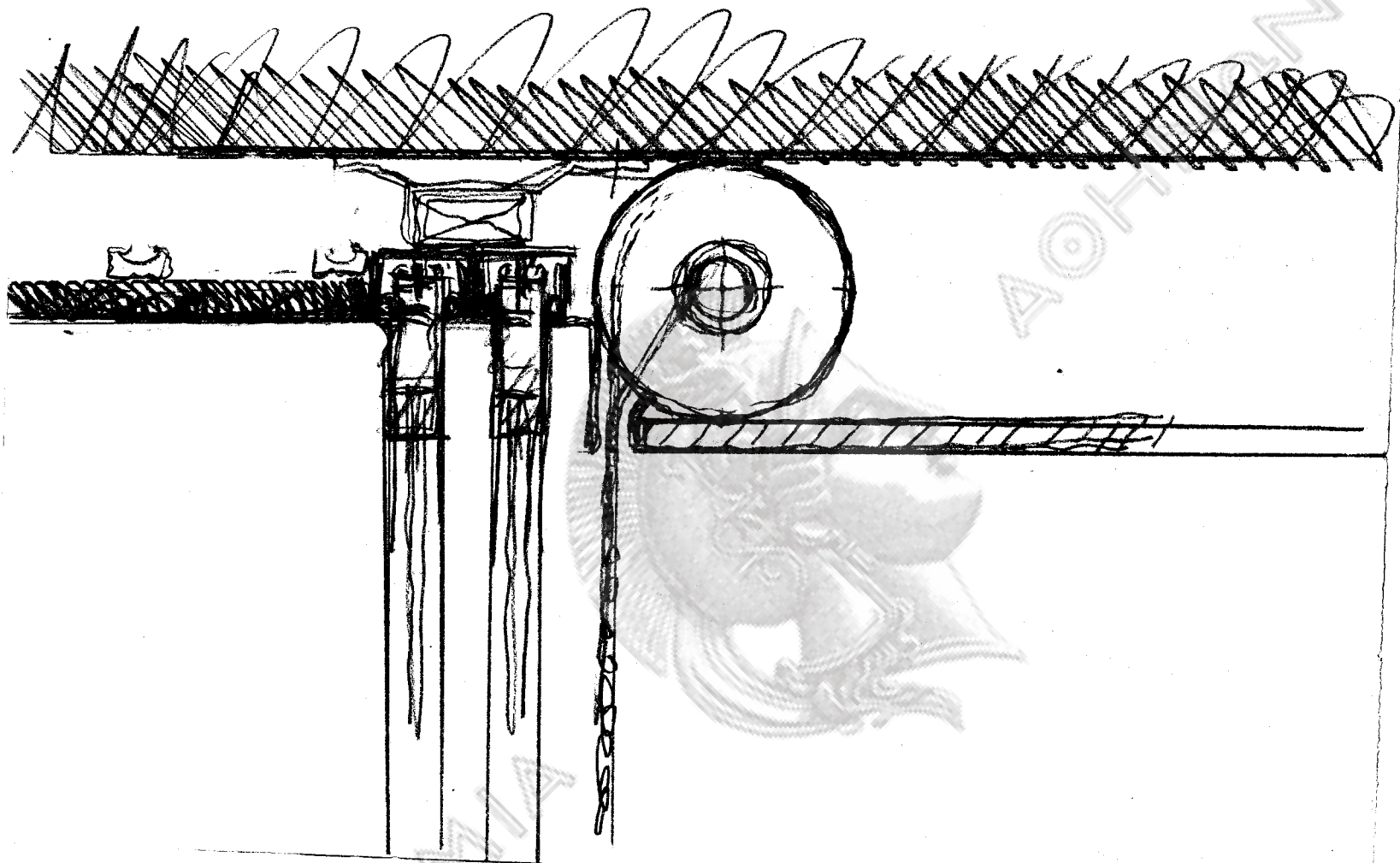

1885

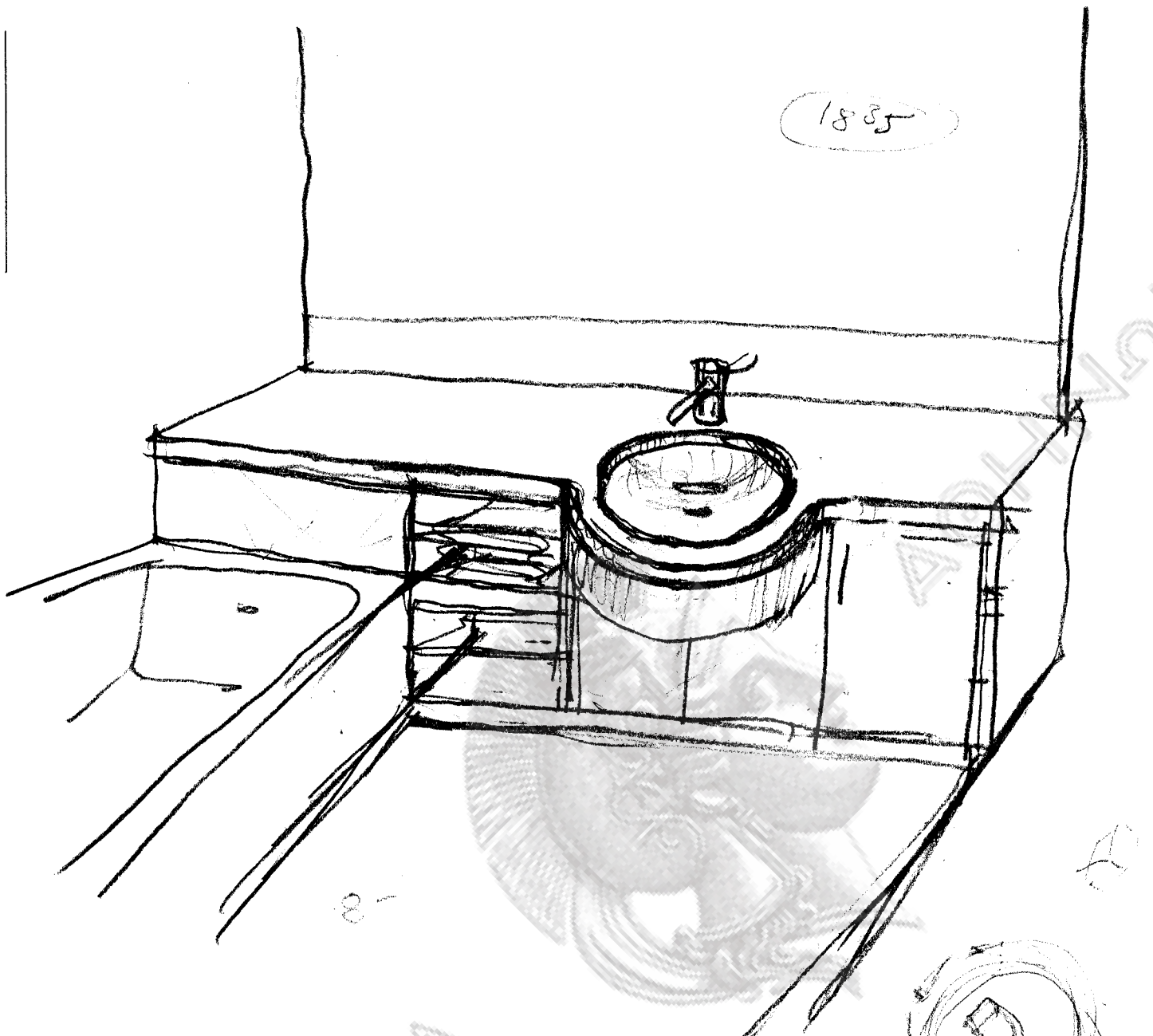

8-

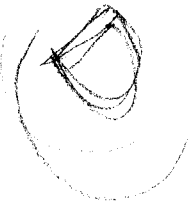
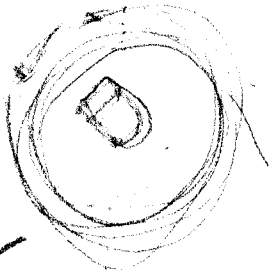

AKAΔHMIA

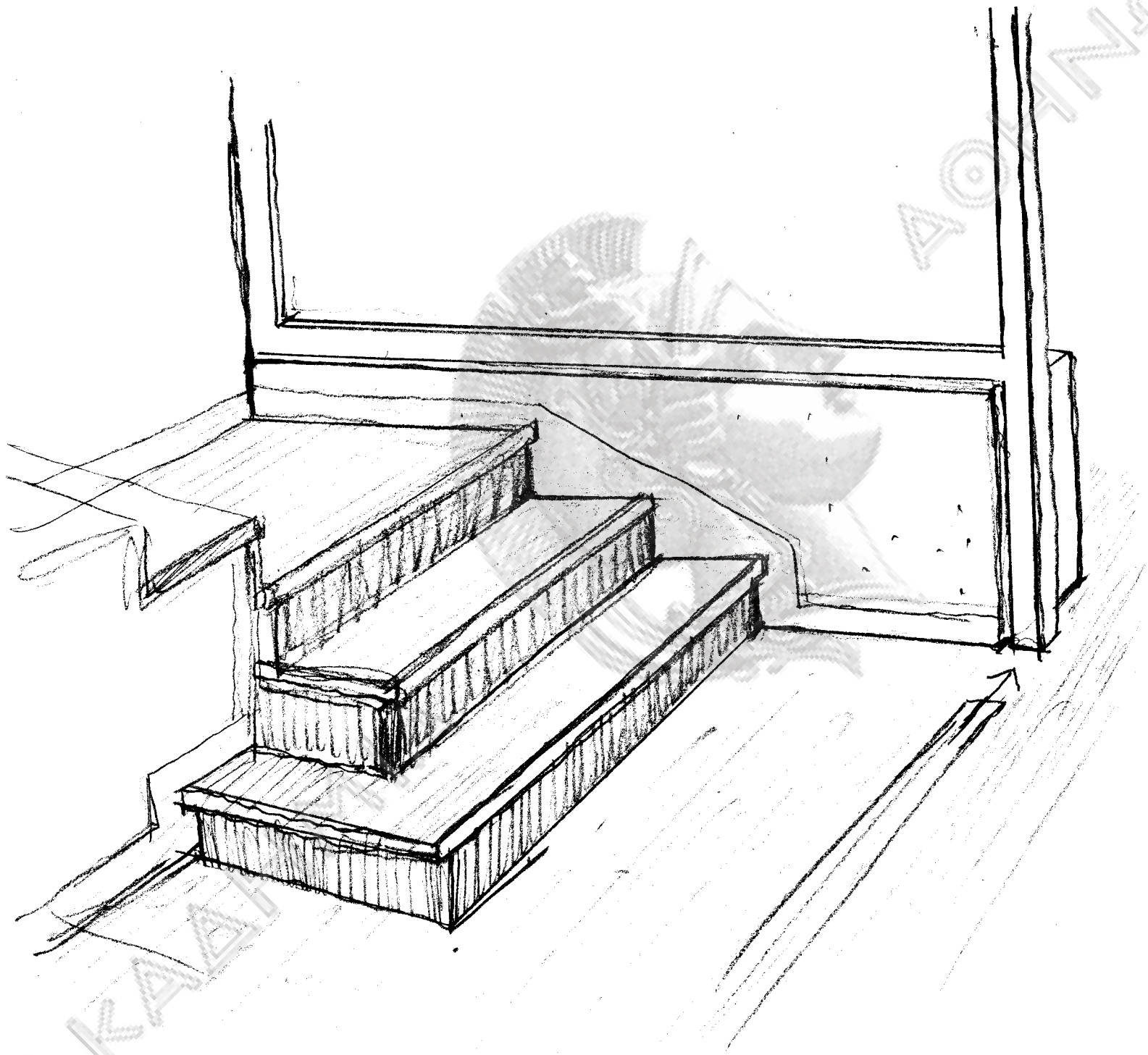

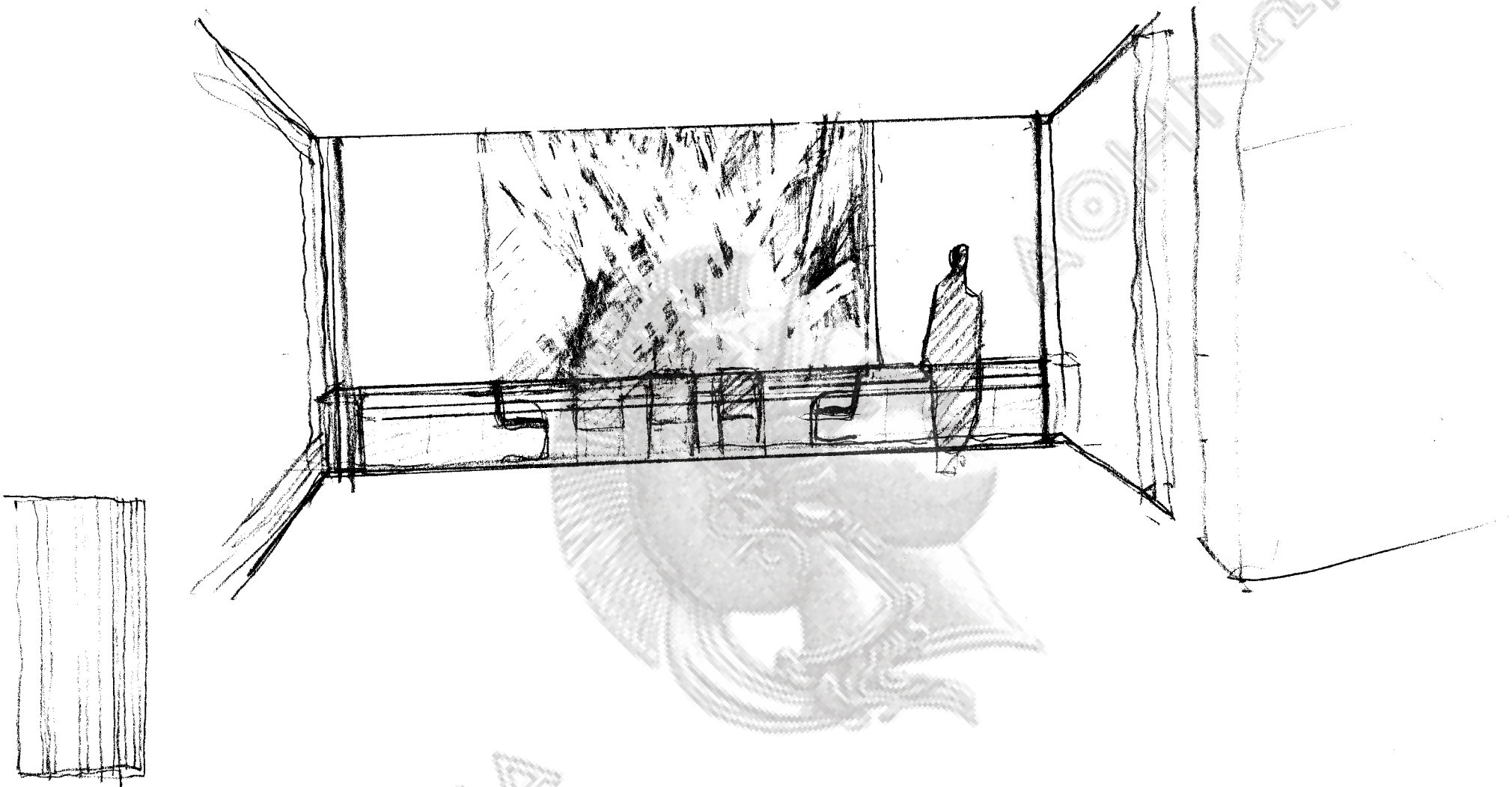

AKAΔΗΜΙΑ

ΜΟΥΣΕΙΟΝ

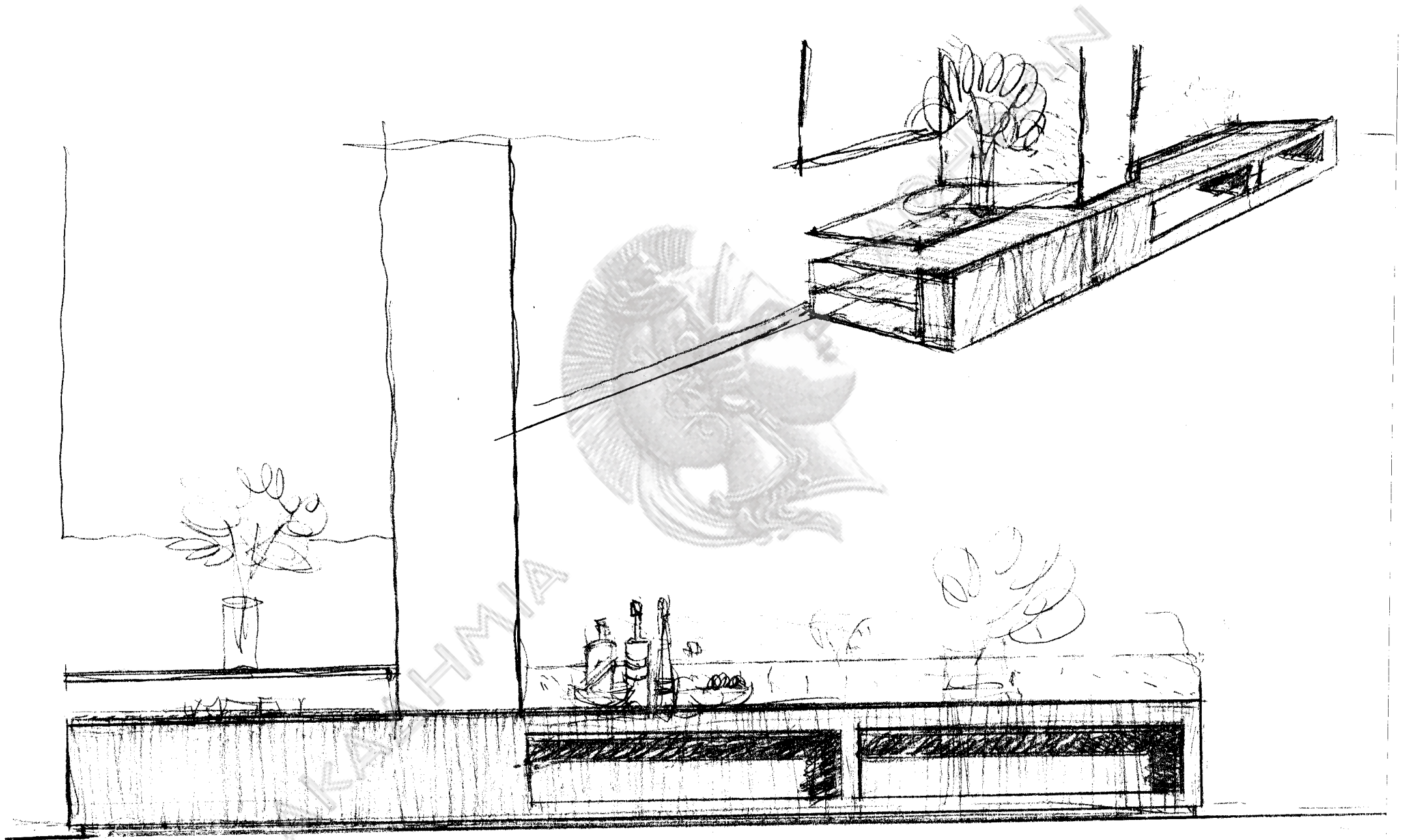

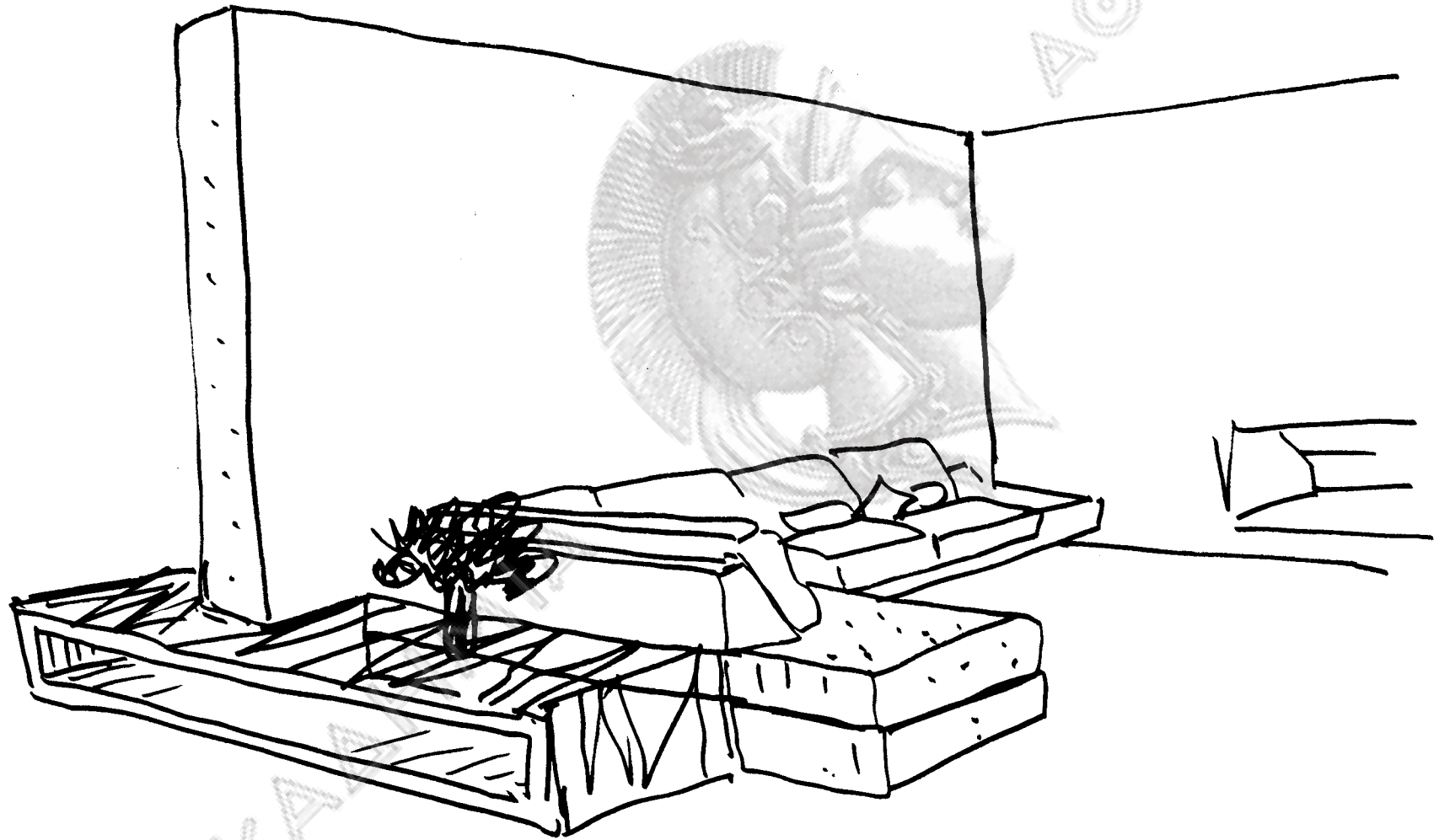

AKA

JOHN

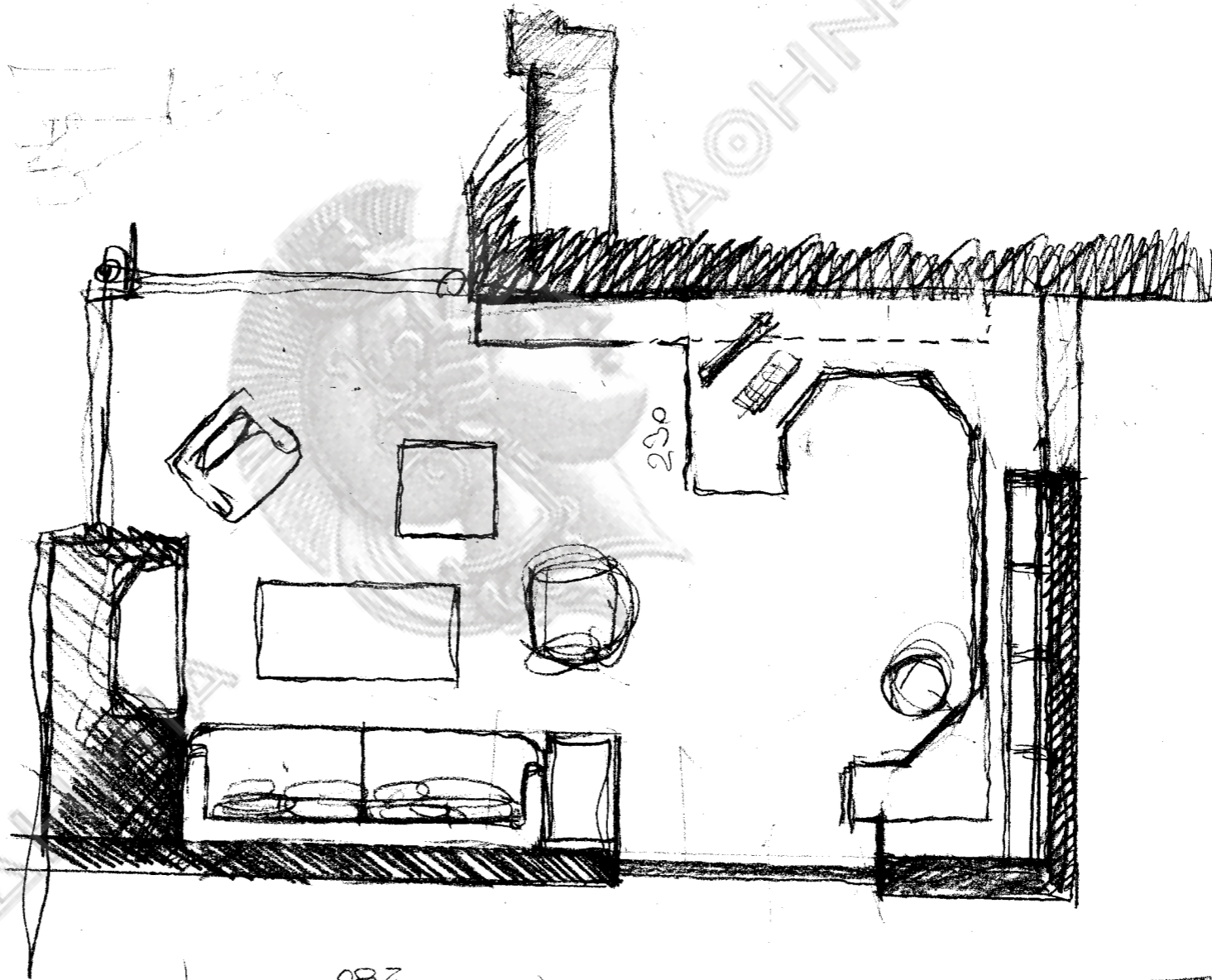
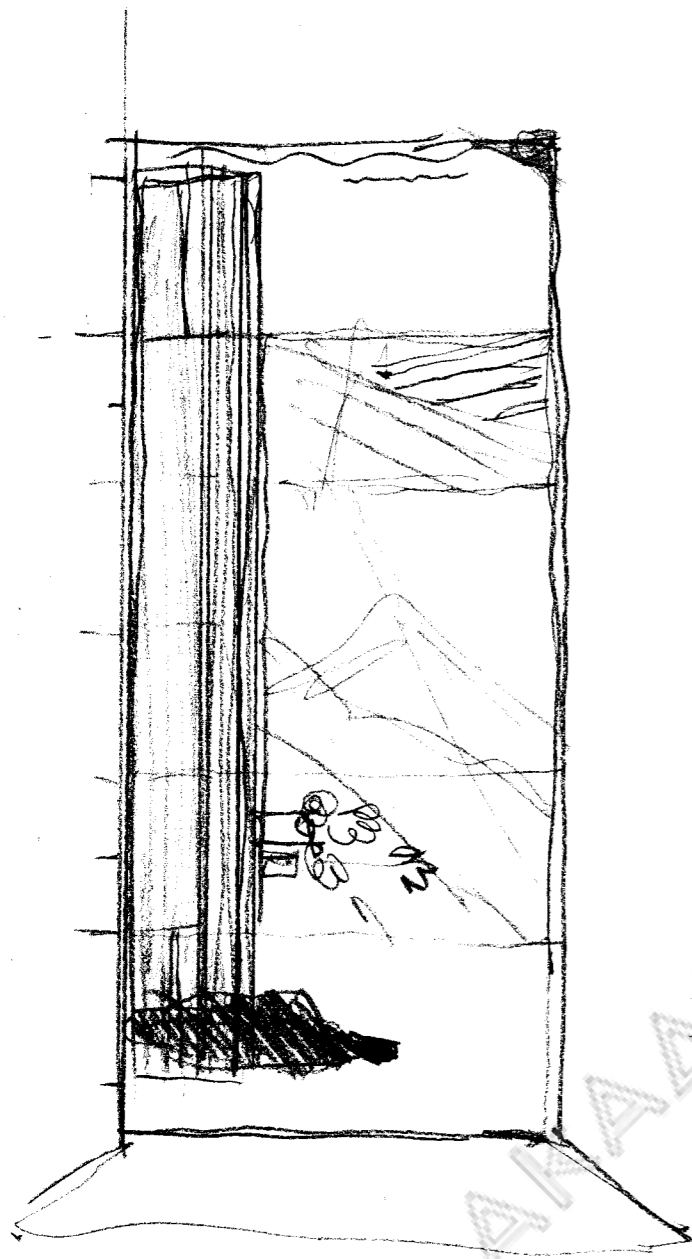

280

230

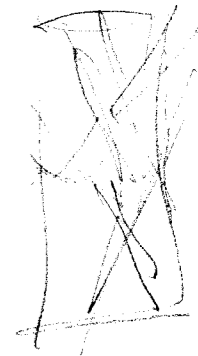
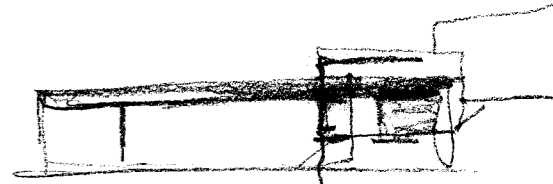

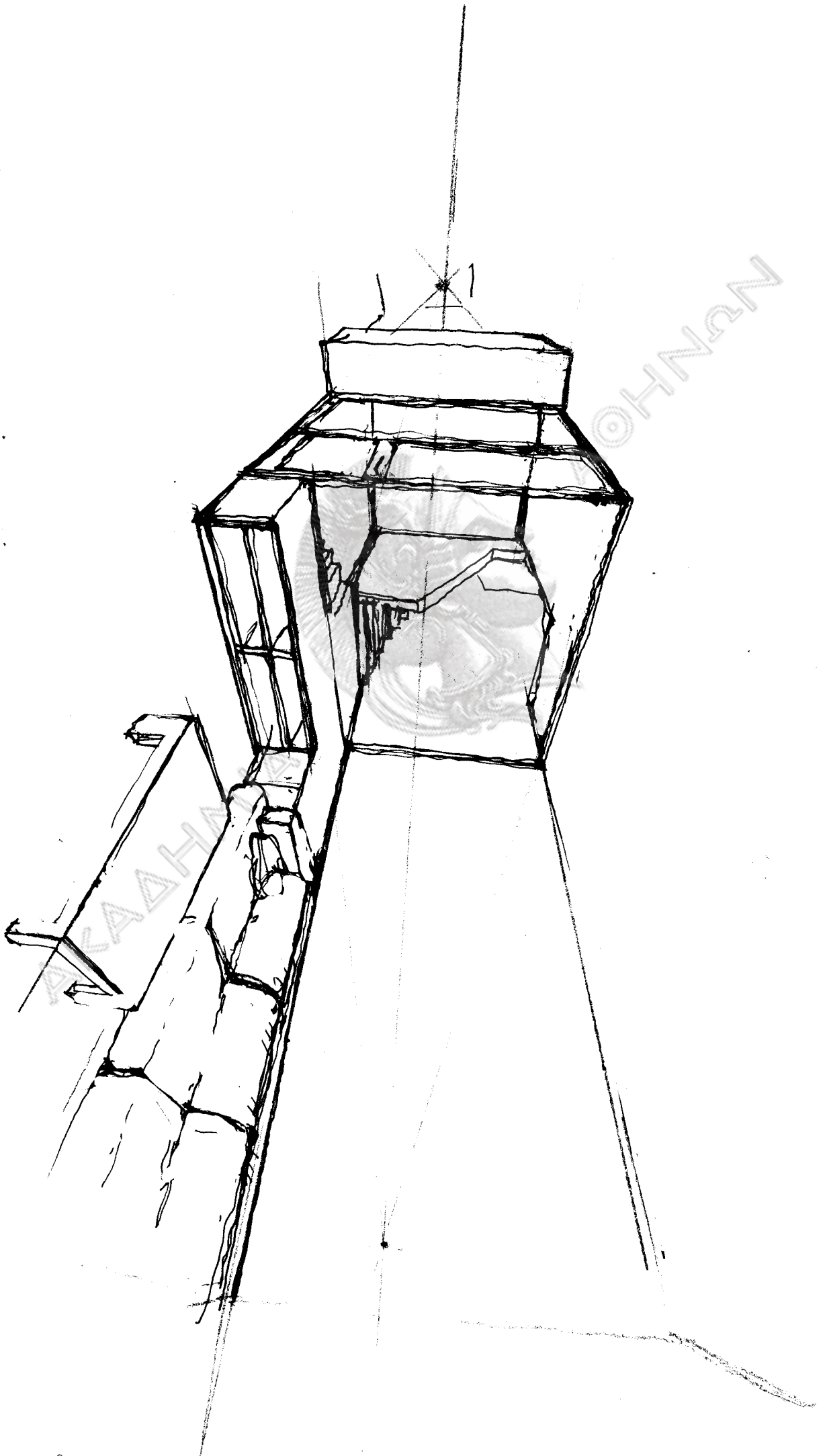

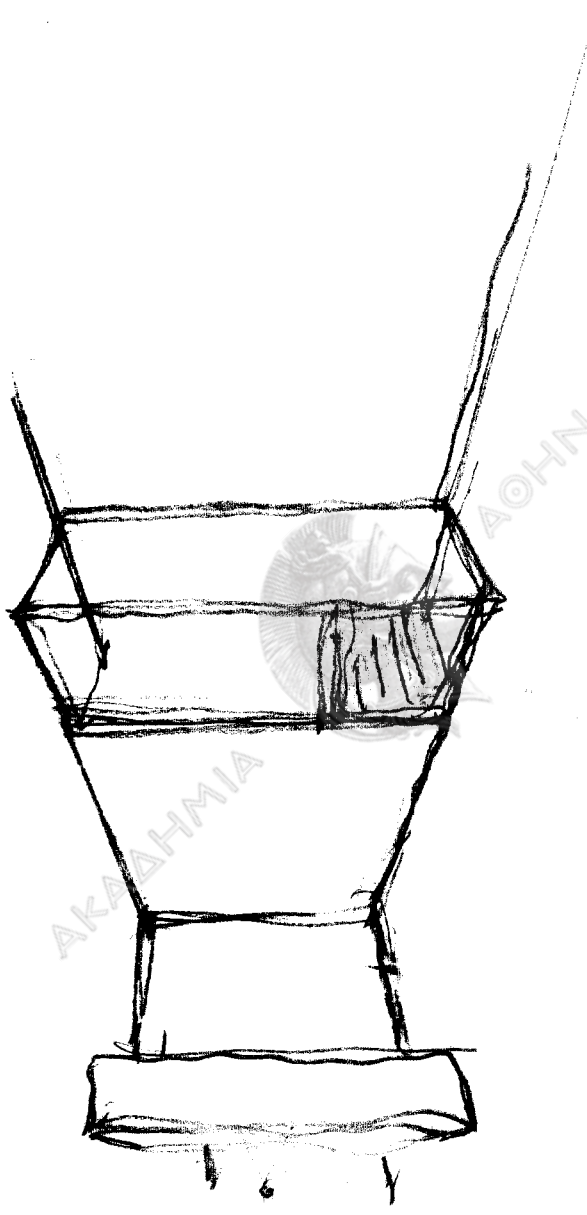

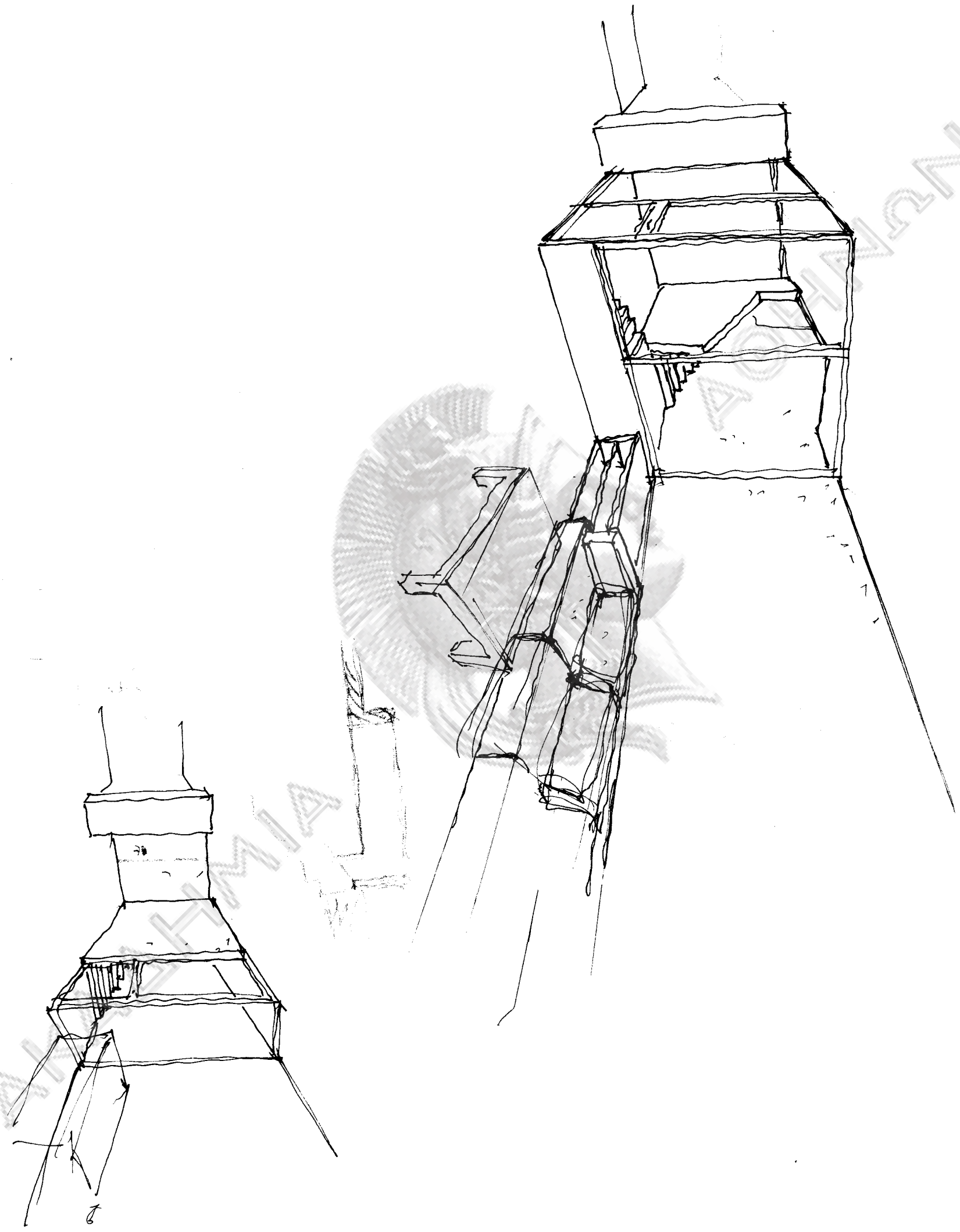

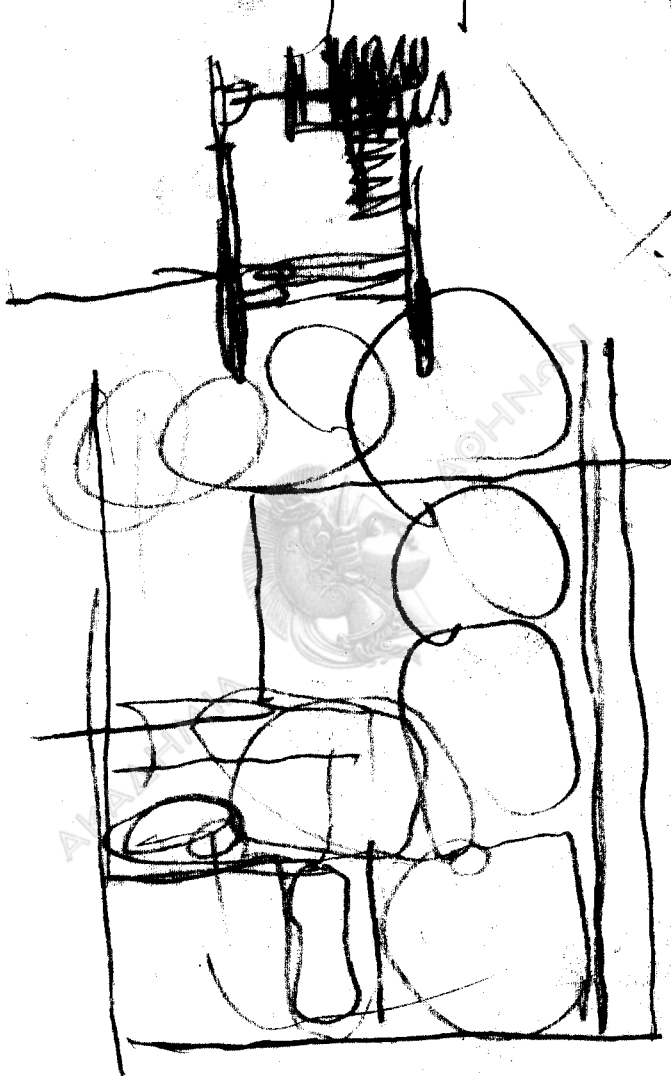



AKAΔHMIA

AΘHNAN

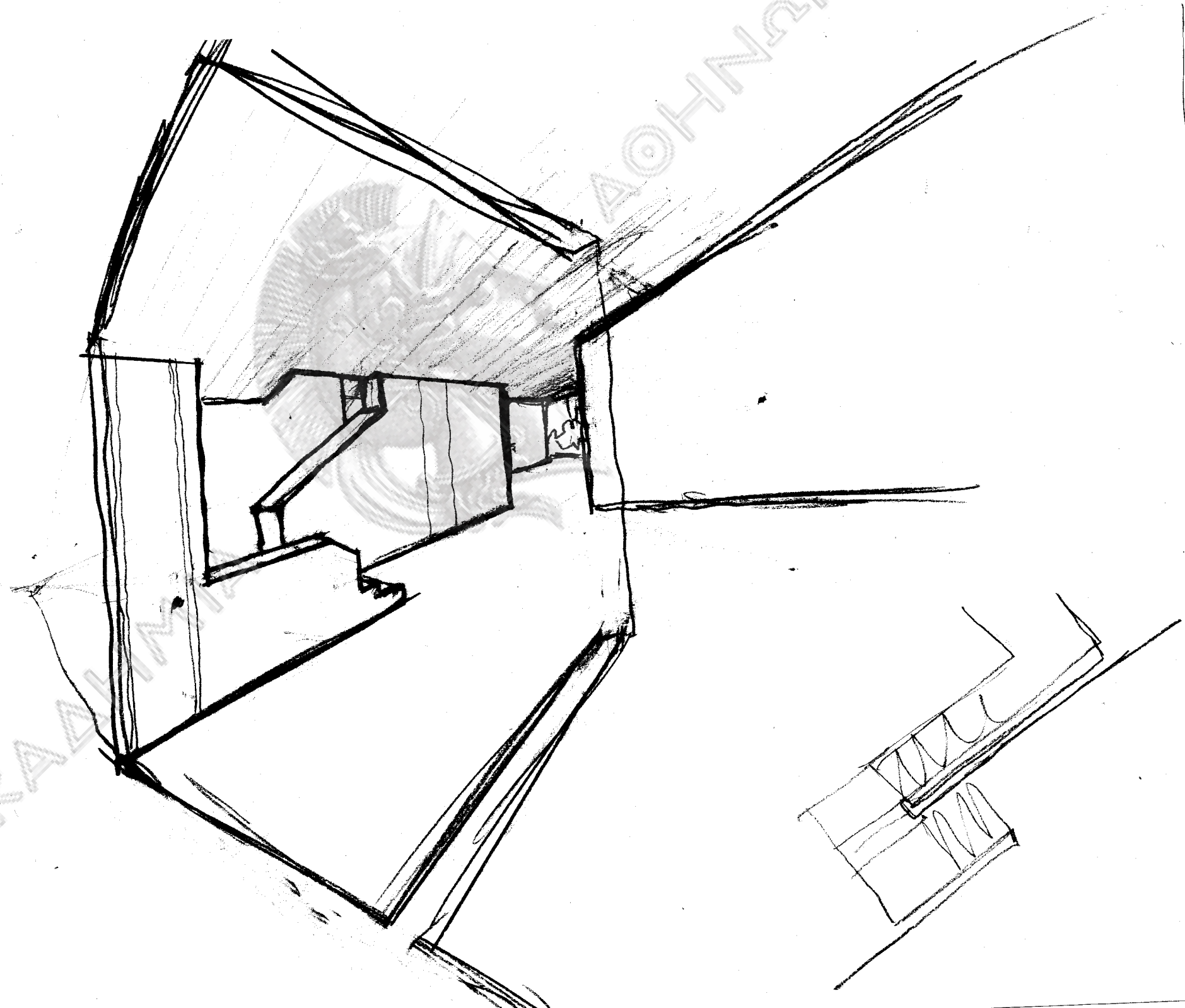

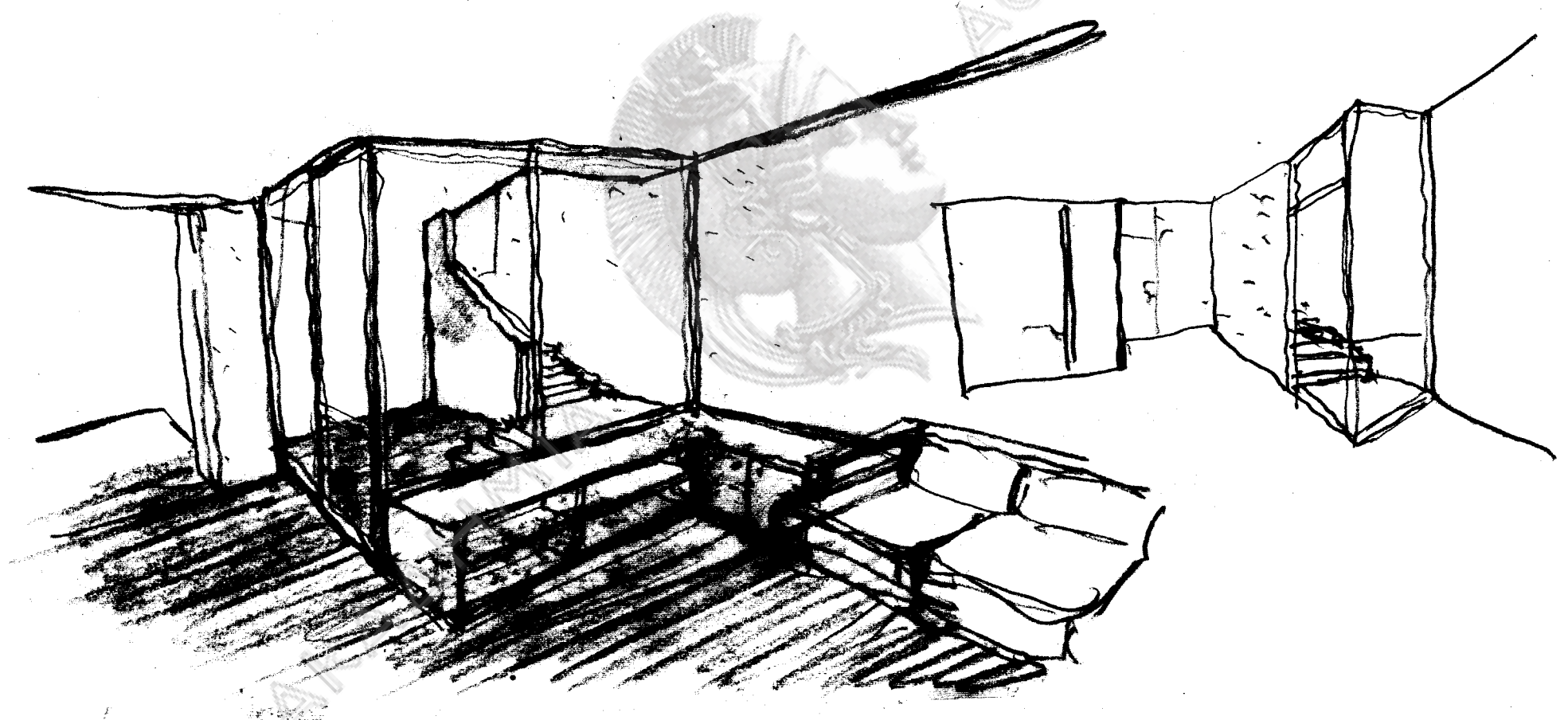

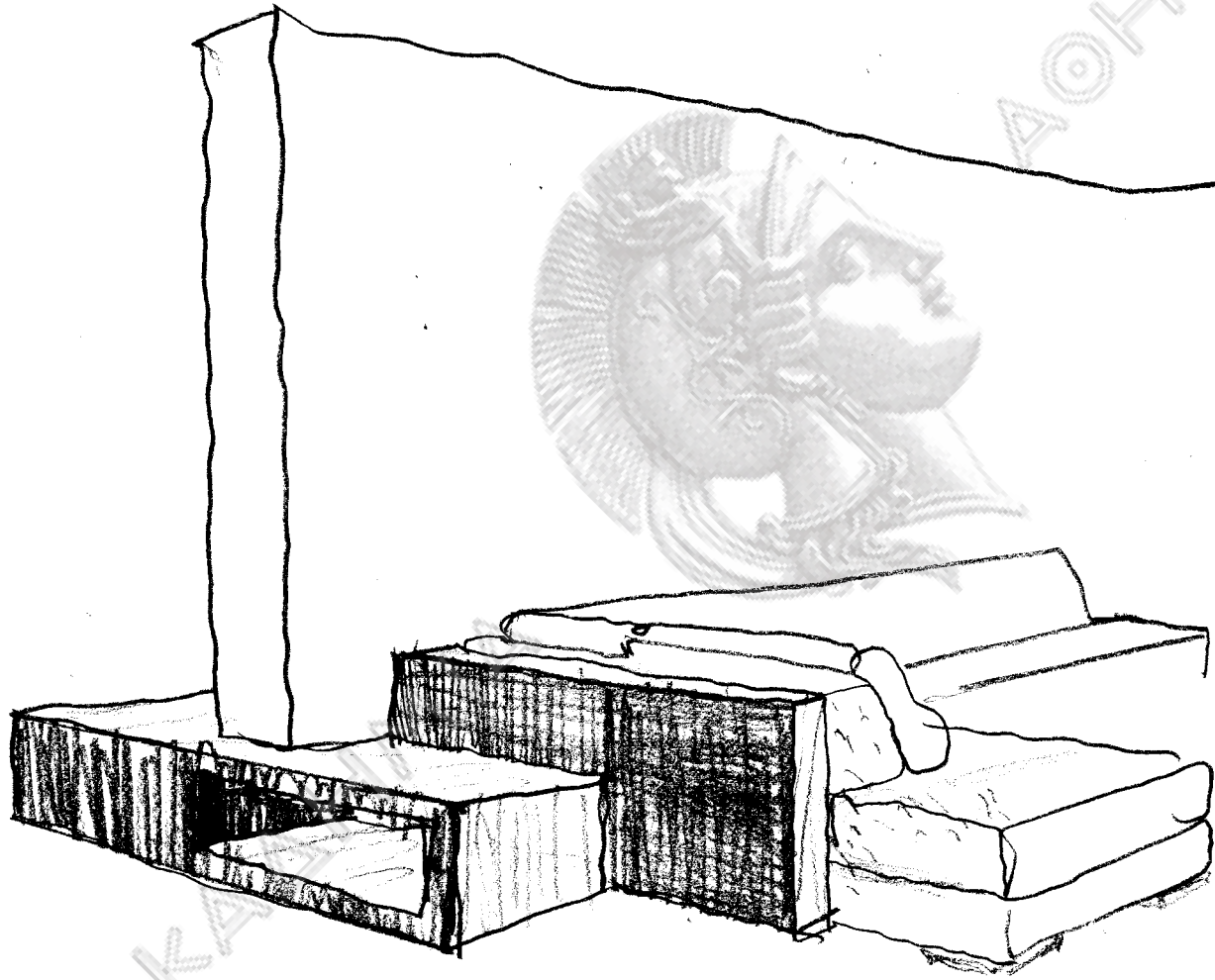

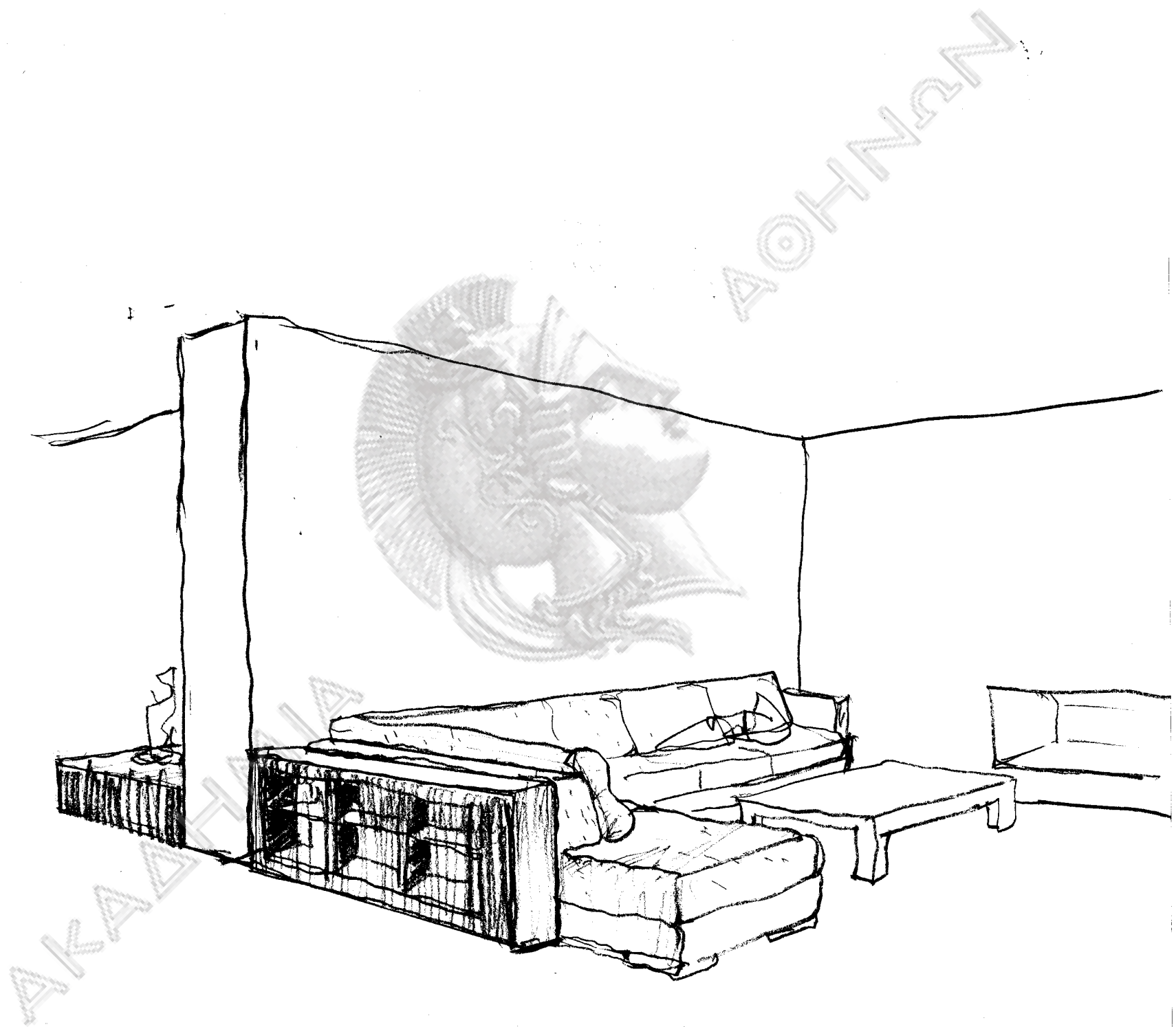

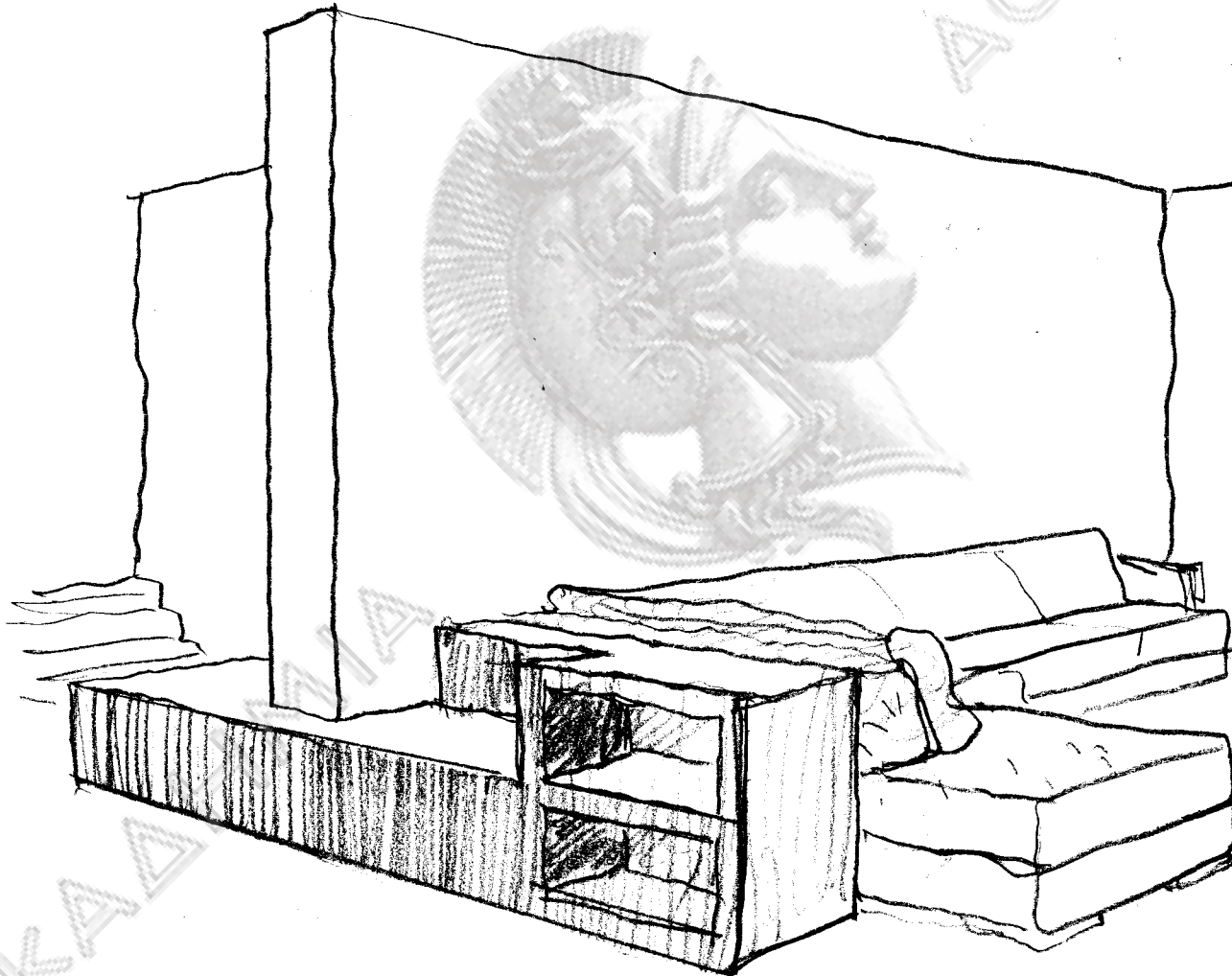

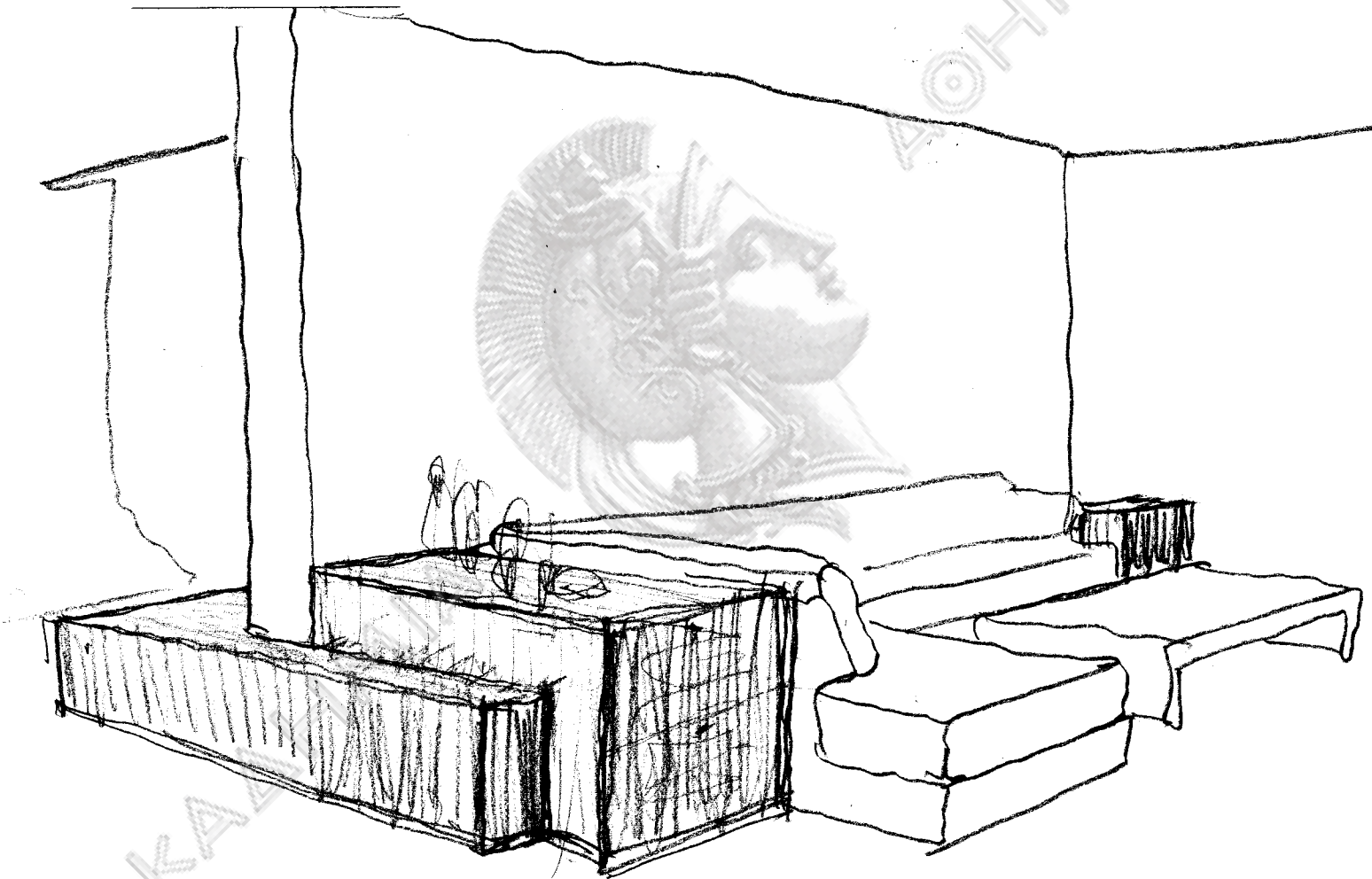

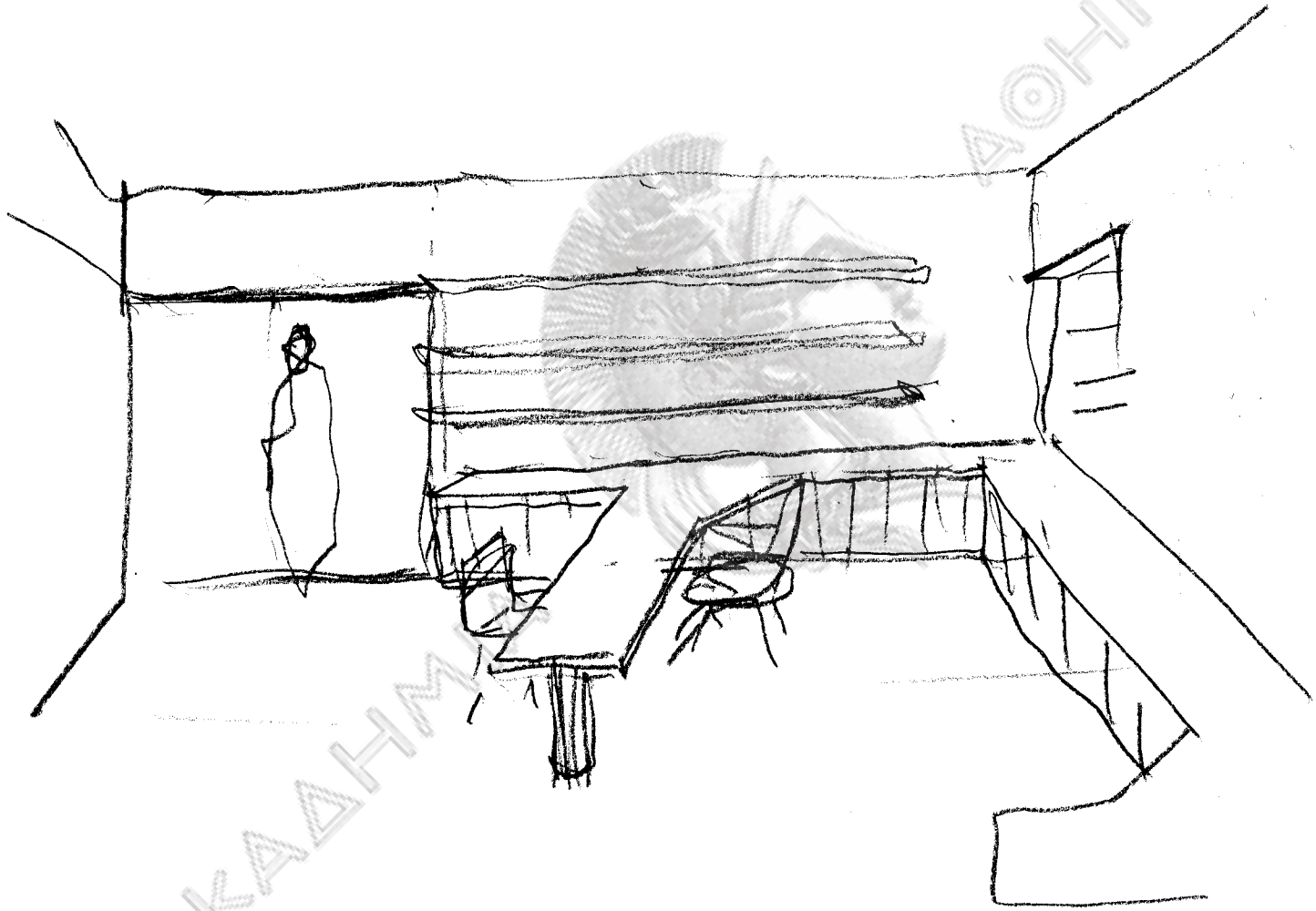

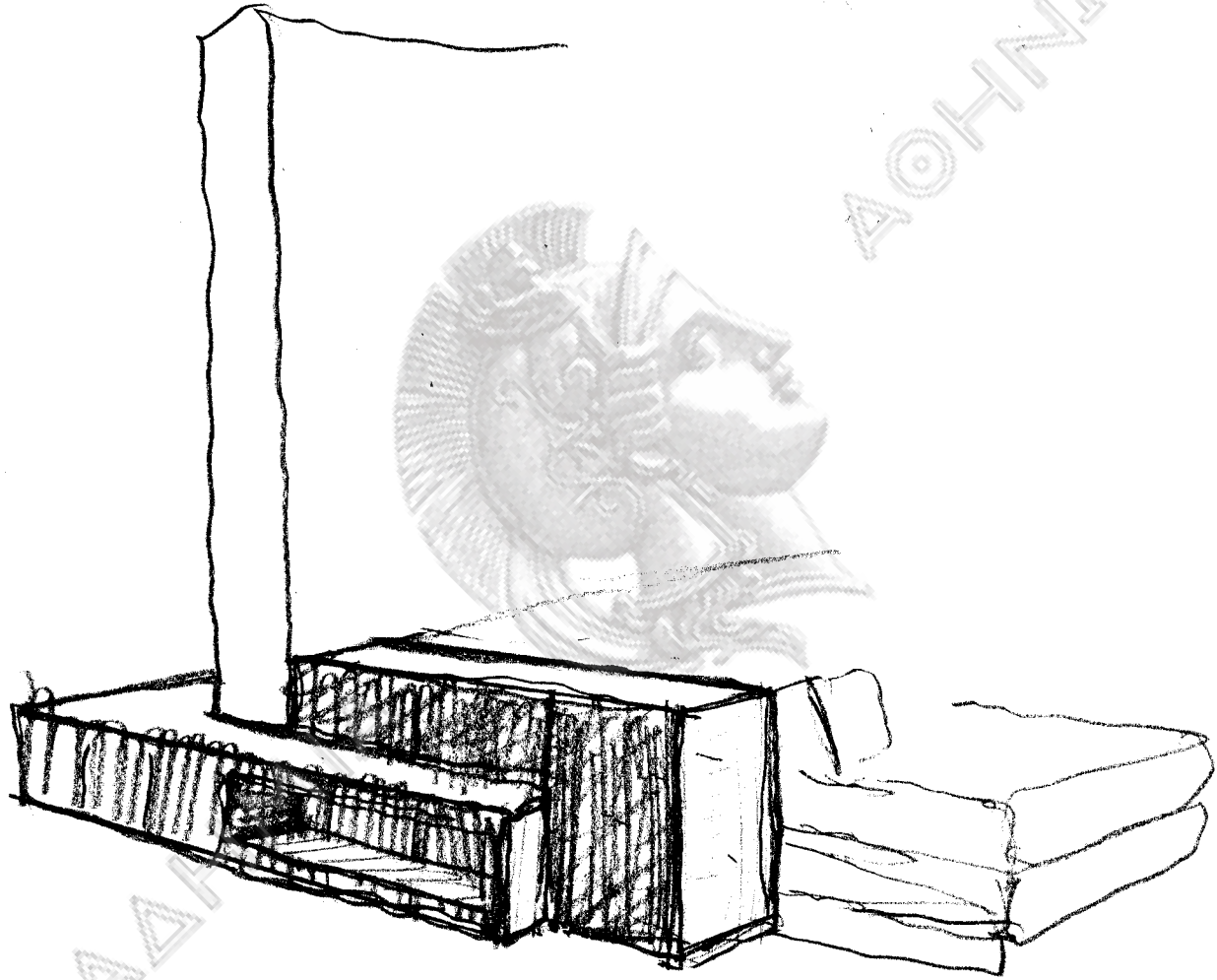

AKADIA

AKADIA

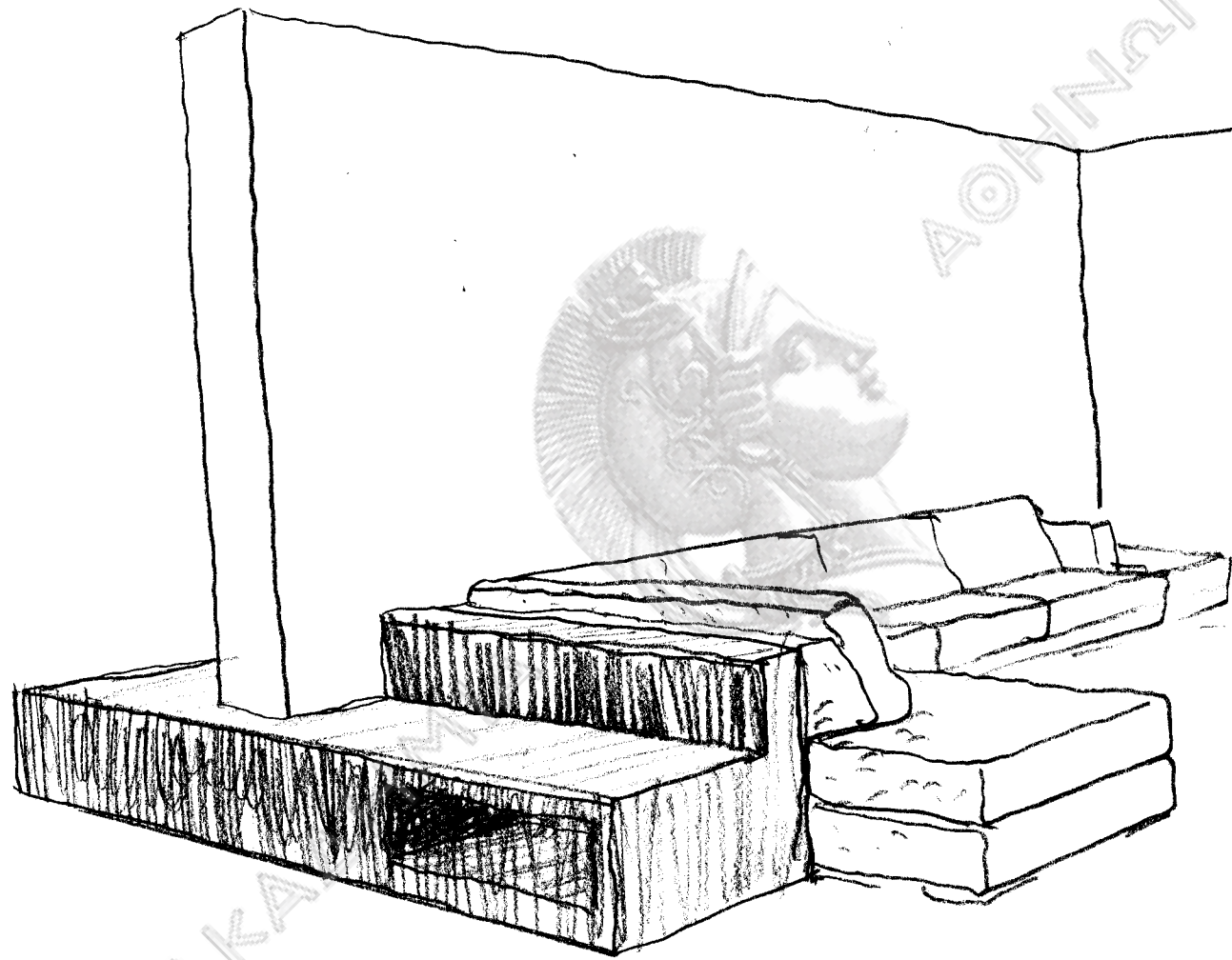

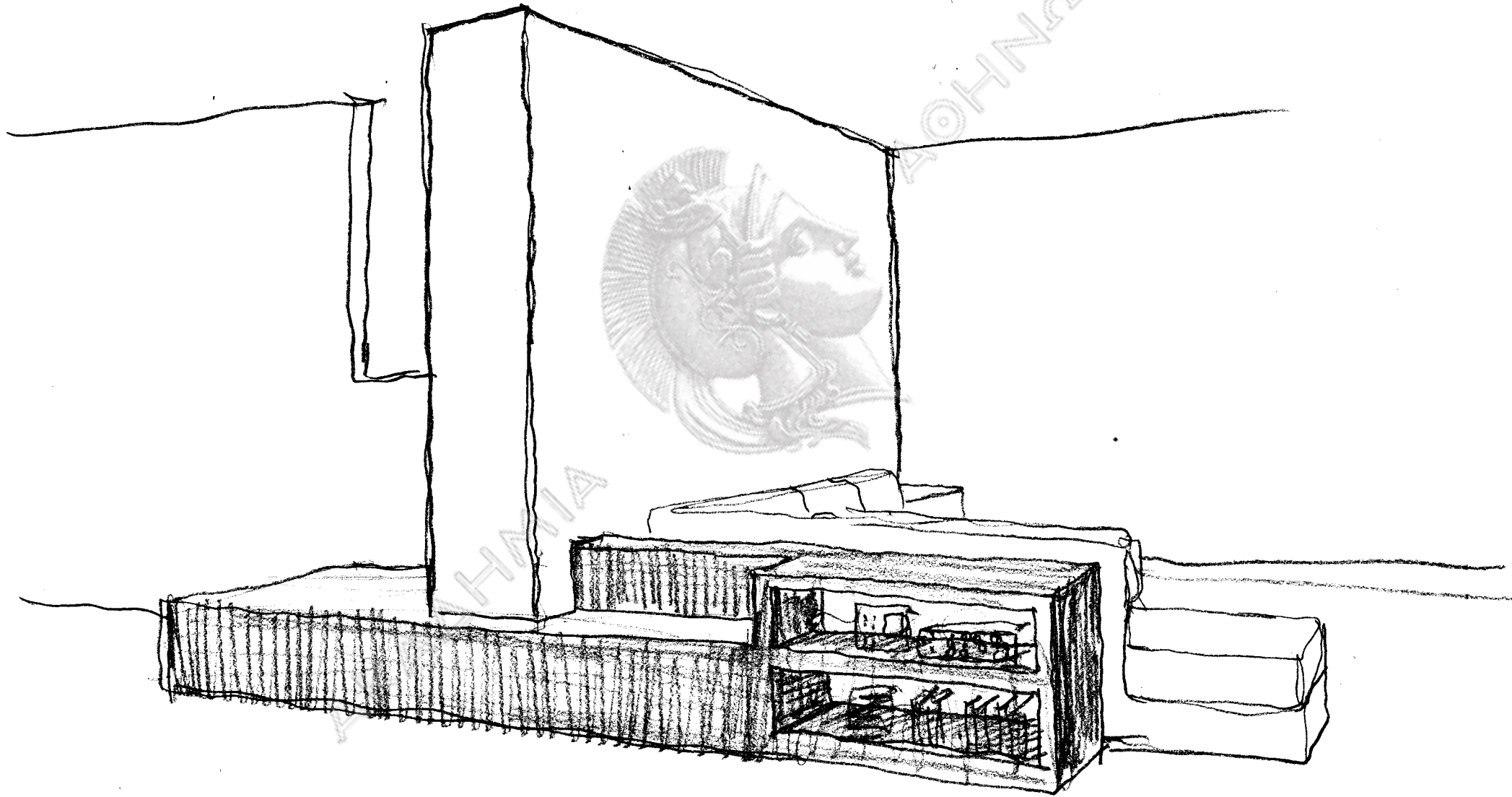

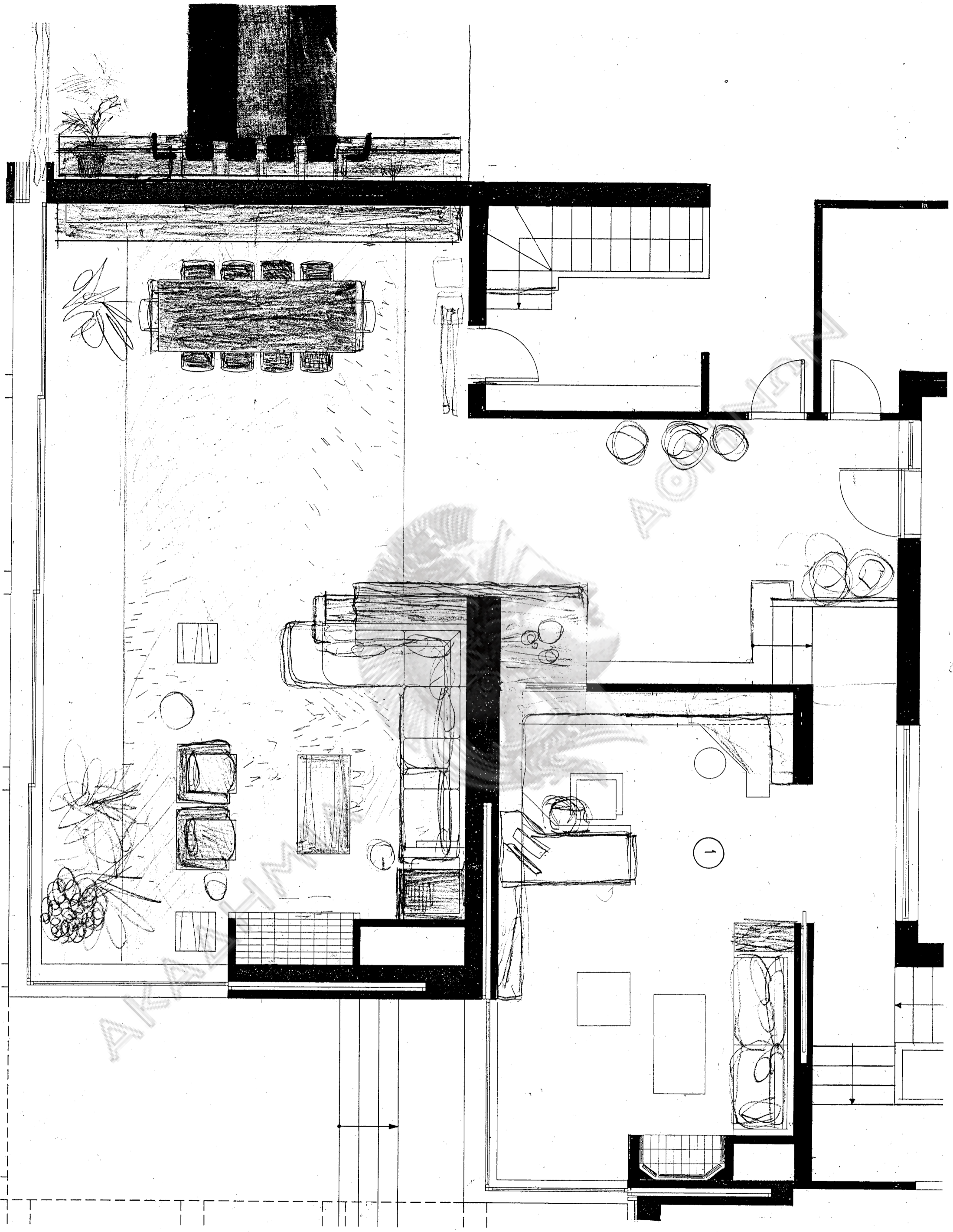

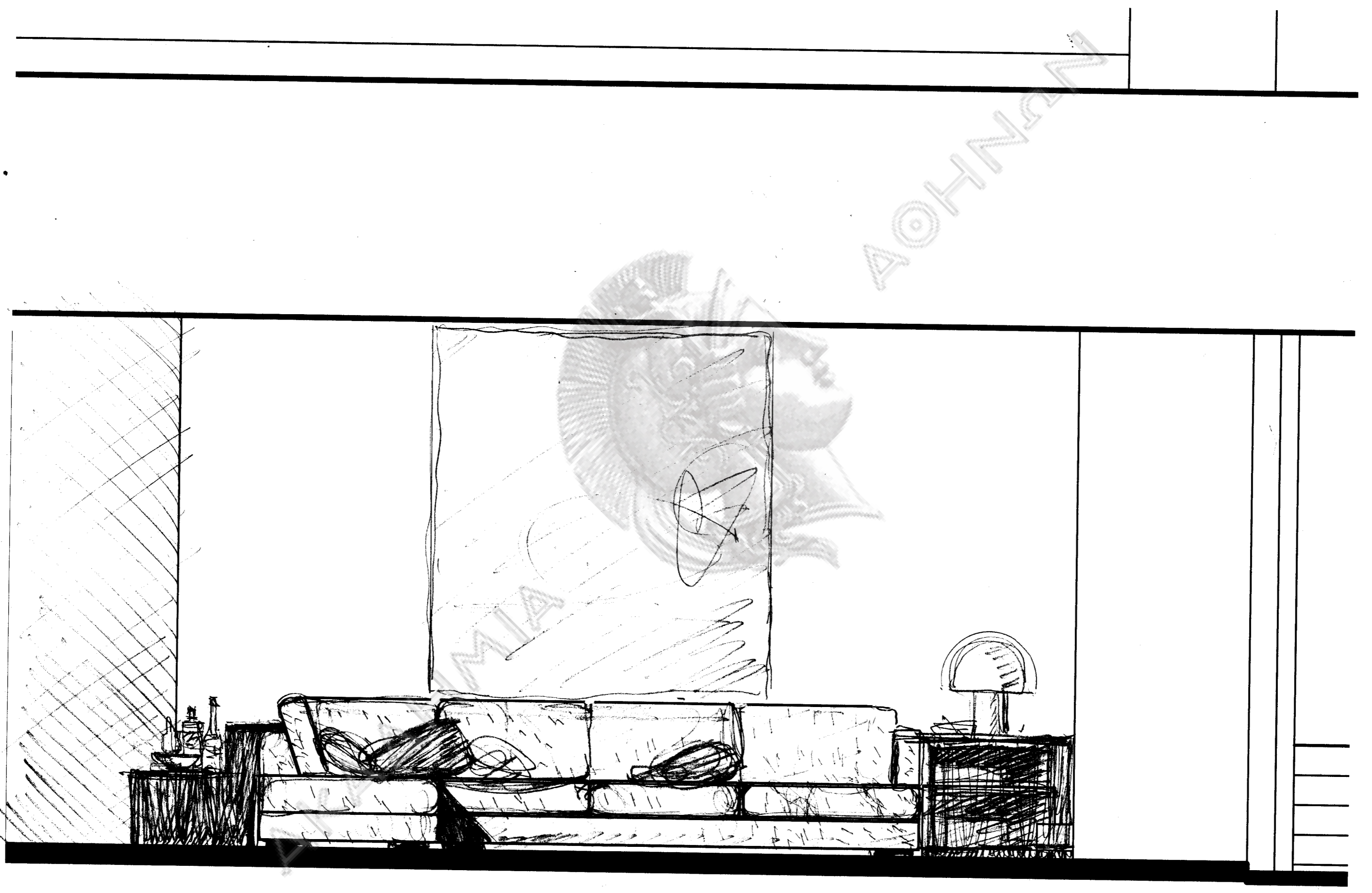

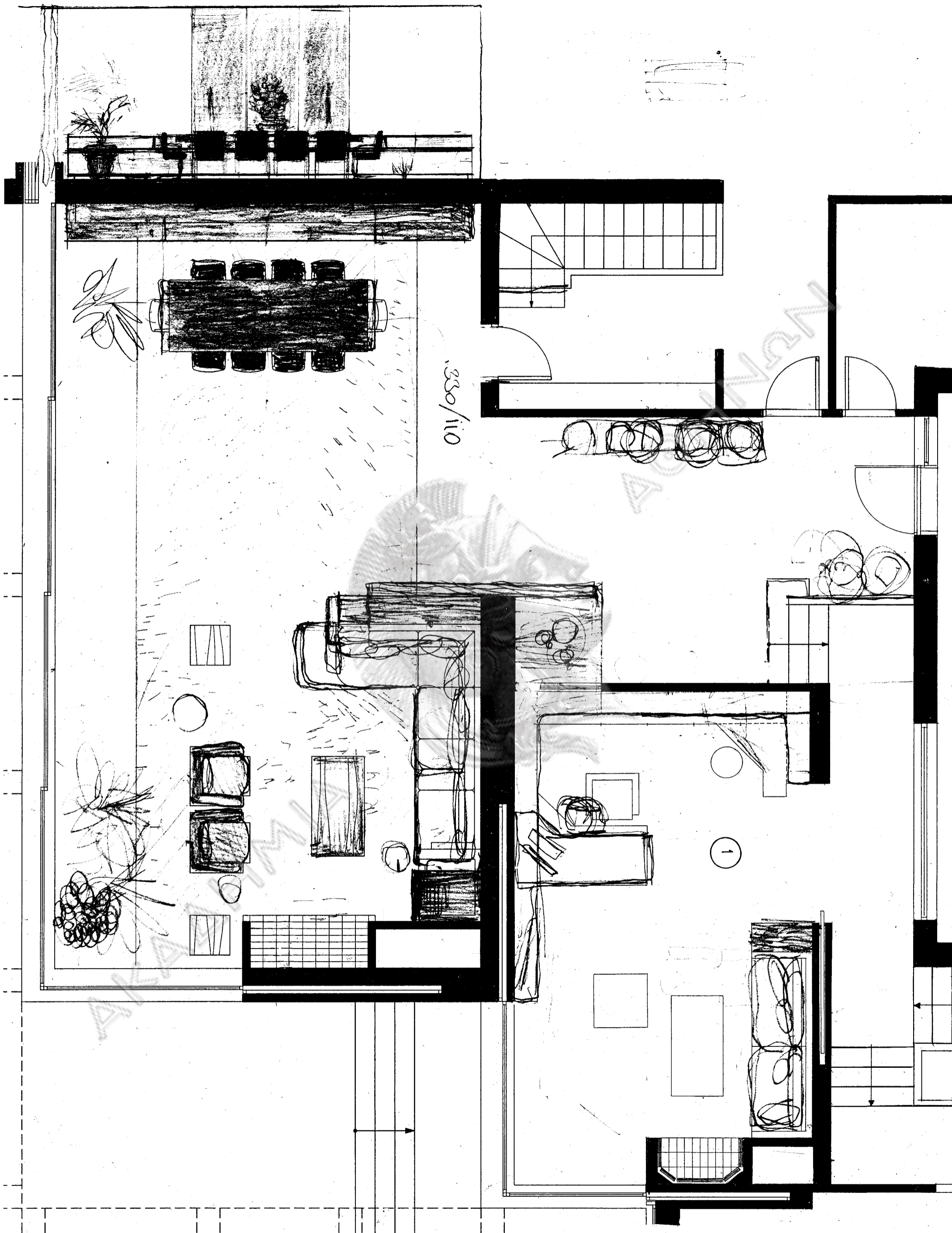

330/110

1

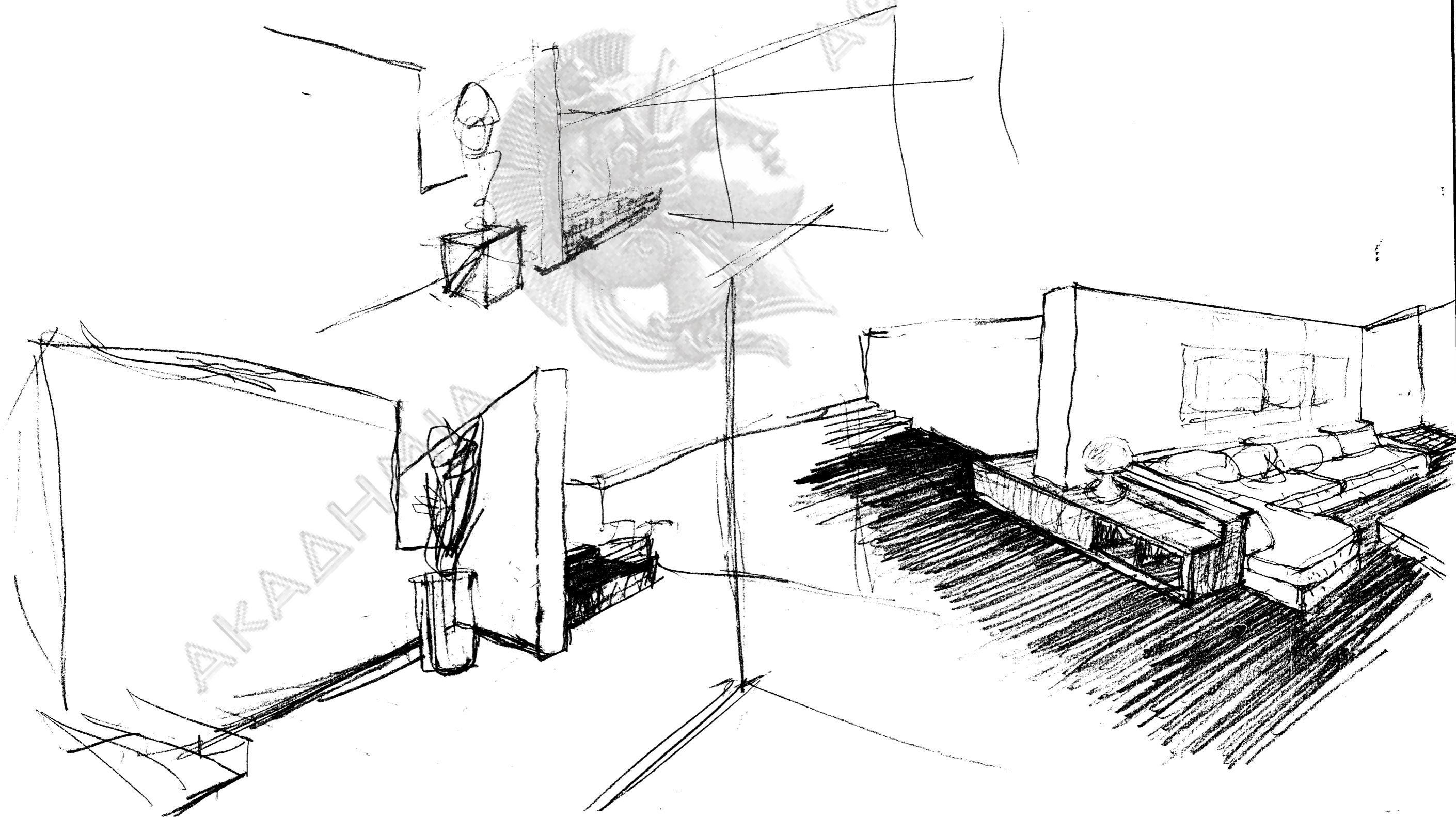

AKADHMIA

